

# DESIGN & INSTALLATION

# Floor

MODULAR  
FLOOR HEATING  
20 mm

Modular Floor



VBOOK8\_EN | 8/2024

PDF



[www.variotherm.com](http://www.variotherm.com)

# VARIOTHERM

# This is how it's done ...



INSTALLATION  
VIDEO

The installation video is no substitute for this planning and installation instructions!

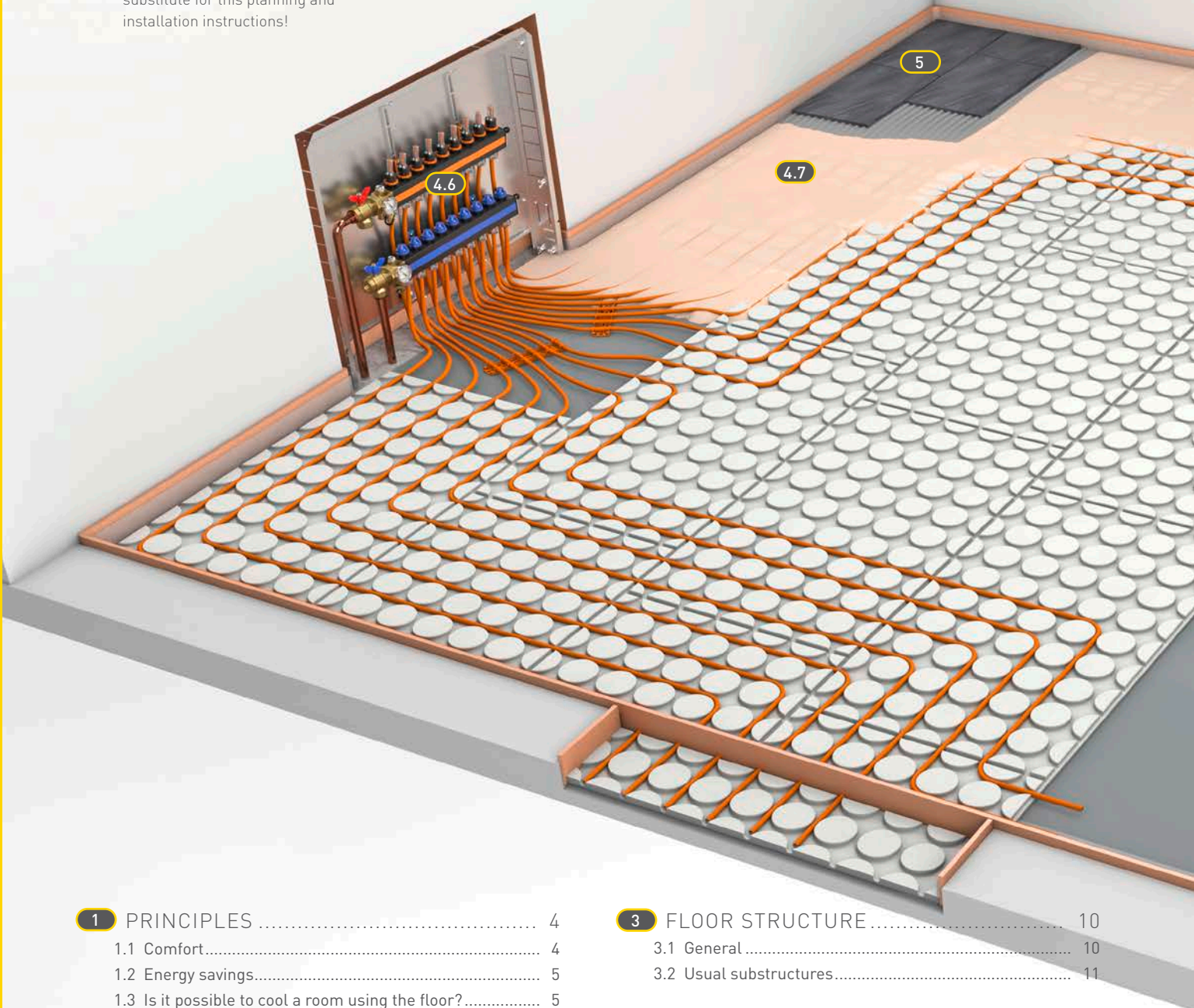

<b>1</b>	<b>PRINCIPLES</b> .....	4	<b>3</b>	<b>FLOOR STRUCTURE</b> .....	10
1.1	Comfort.....	4	3.1	General .....	10
1.2	Energy savings.....	5	3.2	Usual substructures.....	11
1.3	Is it possible to cool a room using the floor?.....	5	<b>4</b>	<b>COMPONENTS &amp; PROCESSING</b> .....	13
1.4	Description and advantages of the VarioComp.....	6	4.1	Edge insulation strip .....	13
<b>2</b>	<b>PRECONDITIONS</b> .....	8	4.2	PE construction foil .....	13
2.1	Warranty conditions .....	8	4.3	Compact underlay boards .....	14
2.2	Information on standards.....	8	4.4	VarioComp boards/blank boards.....	14
2.3	Coordination of the floor structure .....	8	4.5	VarioProFile pipe 11.6x1.5.....	16
2.4	Vapour barrier/vapour retarder .....	8	4.6	VarioManifold / Pressure test.....	20
2.5	Rooms.....	8	4.7	VarioComp filling compound T7 .....	22
2.6	Tools.....	8	<b>5</b>	<b>FLOOR COVERING</b> .....	24
2.7	Movement joints .....	9	5.1	General .....	24
2.8	Humidity.....	9	5.2	Residual humidity of the VarioComp filling compound .....	24
2.9	Transport/storage of goods.....	9	5.3	Filling in a glass fibre cloth .....	25
2.10	Impact sound insulation .....	9			



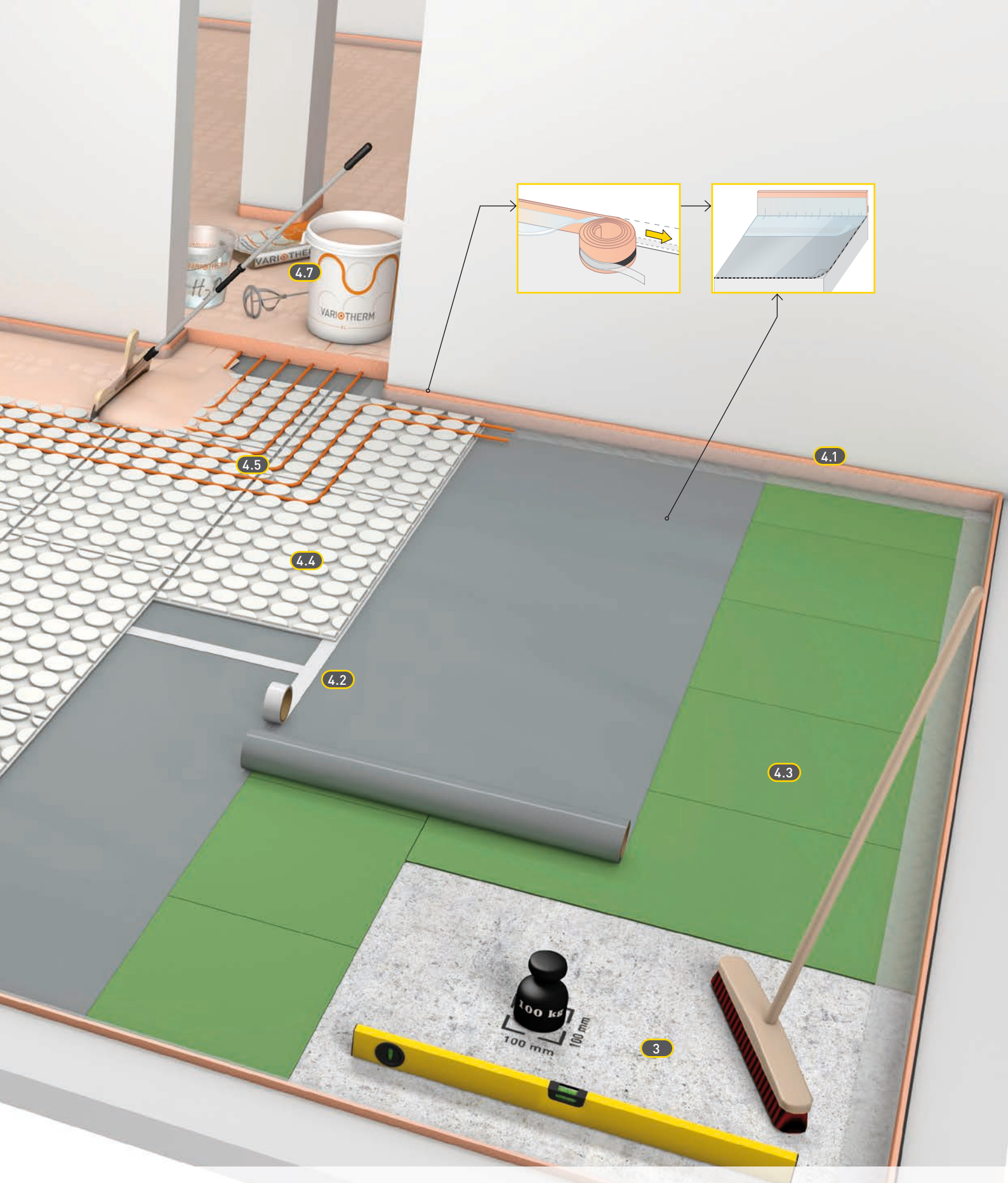

5.4 Application of an additional floor levelling compound .....	25	6.2 Variotherm dimensioning software.....	29
5.5 Rooms exposed to high humidity .....	26	6.3 Heat output .....	30
5.6 Tile, stone and ceramic coverings.....	27	6.4 Pressure loss.....	32
5.7 Soft floor coverings and synthetic resin floors .....	27	<b>7</b> PROTOCOLS .....	33
5.8 Hard floor coverings (parquet, laminate, PVC boards) .....	28	7.1 Leak-tightness test in accordance with EN 1264-4 .....	33
<b>6</b> HEATING PRACTICE .....	29	7.2 Functional heating (in compliance with EN 1264-4 or BVF) ..	34
6.1 Calculating the heating load .....	29	7.3 Commissioning.....	34

# 1 PRINCIPLES

For perfect comfort and optimum energy savings, Variotherm recommends a combination of floor, wall and ceiling heating/cooling system. In general, walls offer the largest exchange area, which is why wall heating/cooling systems ensure that people can easily feel the radiant heat.

The Variotherm floor heating system is ideal for all 'cold' floors. It is an optimum temperature regulator, creating a pleasant atmosphere. The Variotherm floor heating emits long-wave, infrared radiant heat. Consistent with the body's own heat, similar to the heat of the sun, this type of heat is experienced as particularly pleasant.

## 1.1 Comfort

Comfort is not only created through a certain air temperature in the room. The temperature of the surfaces enclosing the room is of equal importance. The felt temperature is roughly consistent with the arithmetic mean of both temperatures.

### What makes people feel comfortable?

People feel comfortable when the following basic 'thermal comfort' equation holds:

$$\text{Heat production} = \text{heat loss}$$

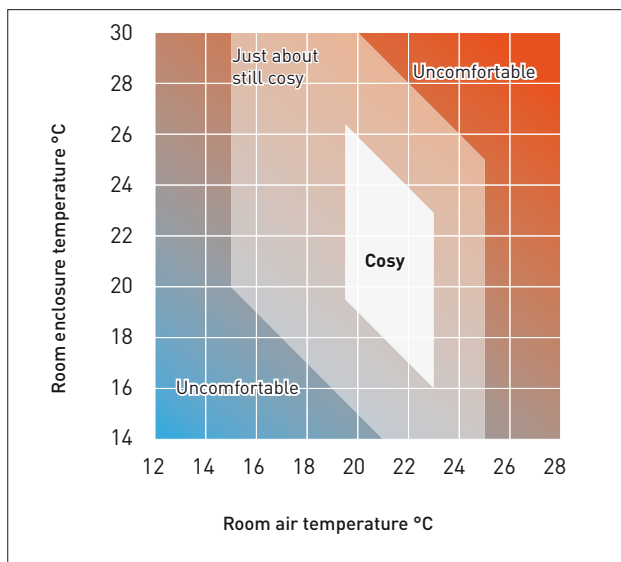

▲ Zone of cosiness

	Heating	Cooling
Ceiling	++	+++
Wall	+++	+++
Floor	++	+

▲ Which system areas are suitable for which needs?

Heat production = heat loss

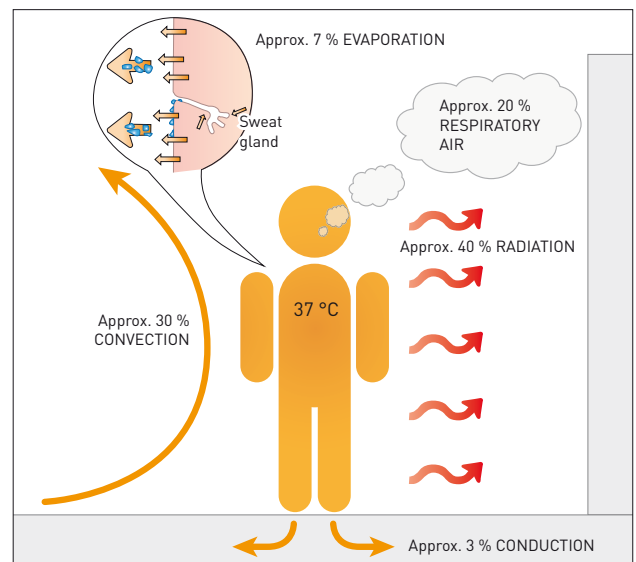

▲ Human heat balance

In this context, it is important that the heat loss from the human body is as evenly distributed in all directions as possible. We feel uncomfortable if too much heat is lost in one particular direction (cold surfaces, draughts) or heat loss is prevented in one direction (hot surfaces or steam-tight, thick clothing). In many cases it is therefore recommendable to install a combination involving the Variotherm wall heating system. Consistent heat transfer ensures that temperature layering in the room is kept at a minimum, promoting the general spreading of a pleasant temperature. In the case of floor heating, the floor is indeed warmer than the air at head-level. Indeed, according to popular wisdom, people stay healthy with a cool head and warm feet'. The room temperature can be set lower than with conventional heating systems. Radiant heat raises the felt air temperature without affecting your comfort.

Since the heat is transferred invisibly via the floor, no visible components have to be planned for, such as recesses for heating devices, radiators and pipes. These almost unavoidable 'subtenants' in expensive living space require a lot of room and are not pleasing to the eye. They restrict both the wall and window design and the space where furniture can be positioned.

Combined floor heating and wall heating systems complement each other perfectly in living spaces. They allow for tailor-made heat supply in every room.

## 1.2 Energy savings

The right surface heating/cooling system not only gives you optimum comfort, it also saves energy and money. The cost of operating a floor heating system can be reduced due to low surface temperatures and hence low heating water temperatures. Surface heating/cooling is therefore ideal where low-temperature energy sources are used, such as biomass, heat pumps, condensing boilers and solar collectors.

The approximate cost savings per 1 K (°C) lower room air temperature are 6 %. Low room air temperature also has the physiological advantage of significantly increasing the absorption of oxygen.

## 1.3 Is it possible to cool a room using the floor?

Cooling via the floor is possible. Real room cooling is only possible in combination with additional areas on the ceiling and/or wall.

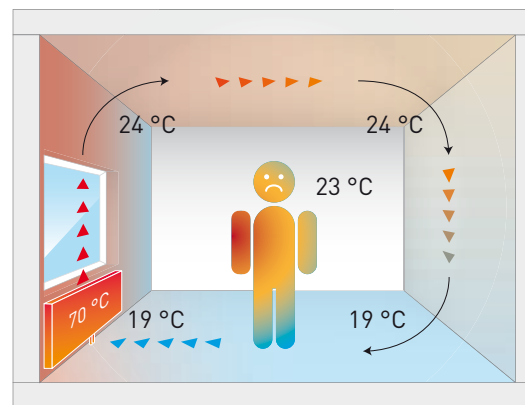

▲ Discomfort with radiators

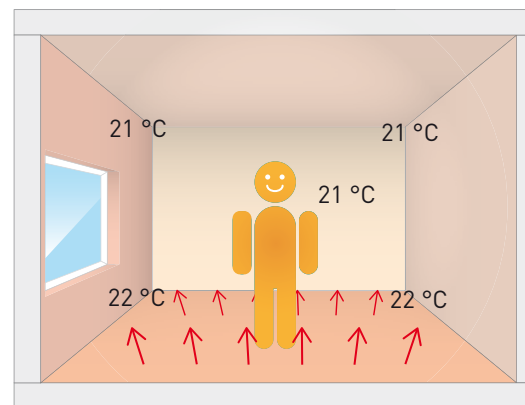

▲ Comfort with floor heating system

### 1.4 Description and advantages of the VarioComp

The VarioComp floor heating system is ideally suited for retrofitting a floor heating system.

All components of the complete system are perfectly matched:

- › The specially milled routings of the VarioComp board
- › The easy to bend VarioProFile pipe with an extremely stable form
- › The fast-drying VarioComp filling compound
- › The ideal height for the optional XPS or SILENT underlay board

The fast reaction time allows good control of the room temperature even in sunny rooms. The complete system has been checked, tried out in practice and has been awarded with a number of quality certificates.

The VarioComp floor heating was subjected to comparison measurements with a screed floor heating system (VarioRoll, pipe spacing: 100 mm, screed covering of the VarioProFile pipe: 40 mm) for 24 hours.

The faster heating of the surface of the VarioComp floor heating compared to the screed floor heating system can be clearly seen. The reaction time of the surface temperatures to reduced flow temperature is shorter.

This results in:

- › Better control of the VarioComp floor heating. The surface temperature during heating is greater than that of the screed floor heating system.
- › More efficient layout of the heating surfaces because lower flow temperatures than those used for other floor heating systems are possible.

# Advantages VarioComp

- › Construction height just 20 mm
- › Low weight (25 kg/m<sup>2</sup>)
- › Rapid construction progress – fast drying times: Ready for covering after just 24 hours
- › Ideal for renovations
- › Routing system throughout, allowing pipes to be laid flexibly
- › High heat output – lower flow temperature
- › Rapid reaction times

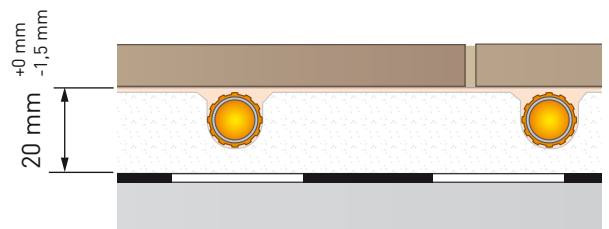

▲ System height and tolerances

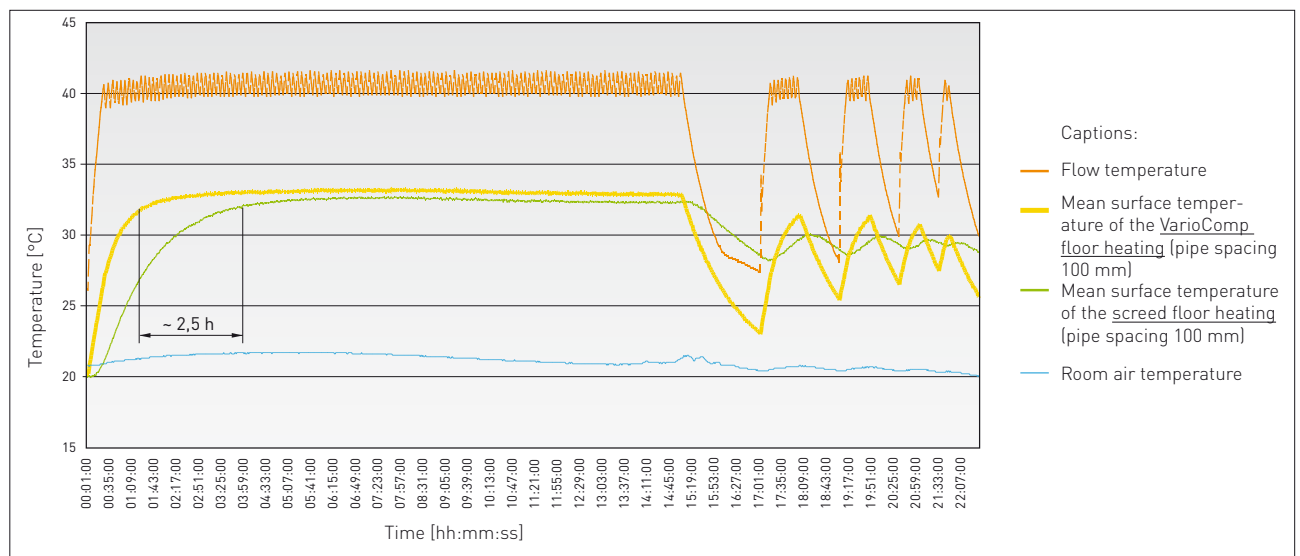



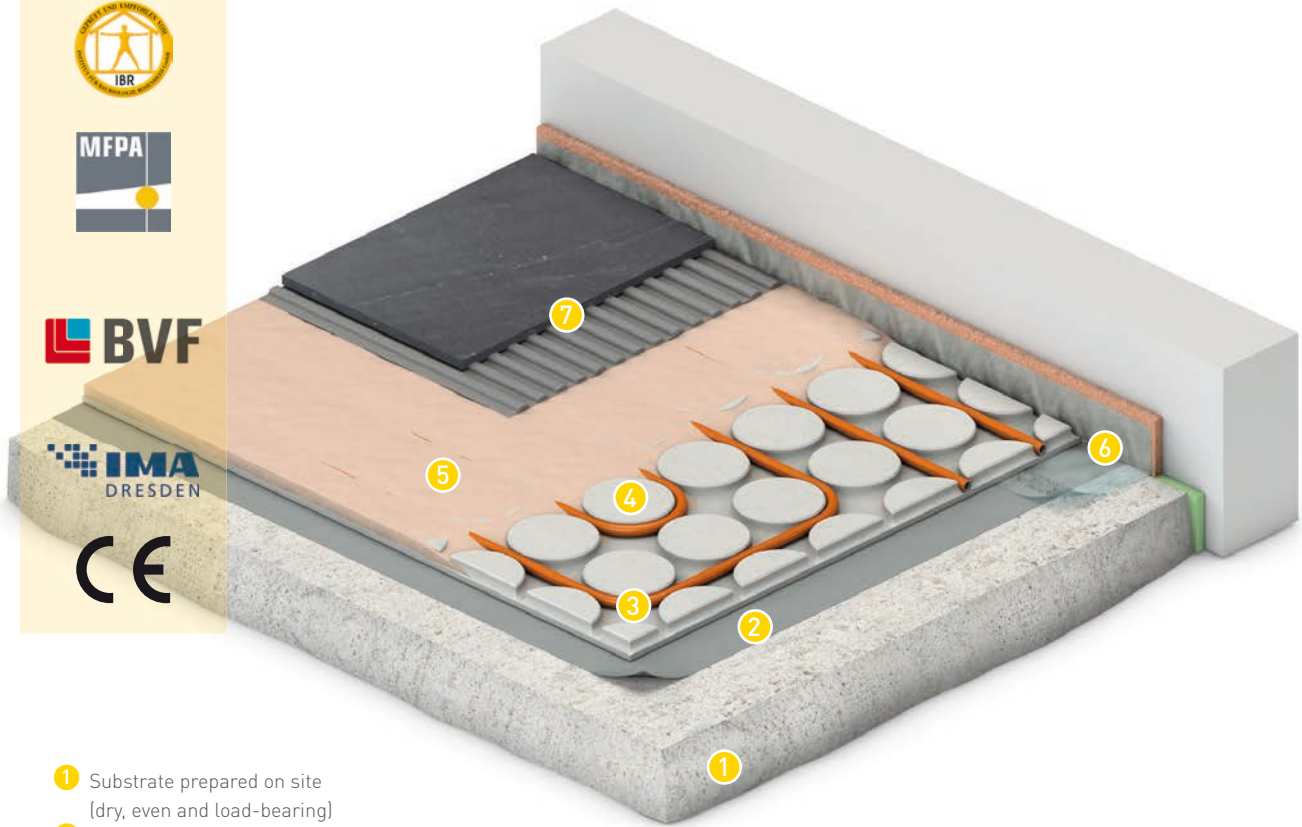

- 1 Substrate prepared on site  
(dry, even and load-bearing)
- 2 PE construction foil
- 3 VarioProFile pipe 11.6x1.5
- 4 VarioComp board
- 5 VarioComp filling compound
- 6 Edge insulation strip with overlap foil
- 7 Floor covering: Here, you can choose  
whatever you like: wooden parquet, tiles,  
stone flooring, laminate or carpet.



▲ VarioComp boards 18 mm  
(pipe spacing 100 or 150 mm)



▲ VarioProFile pipe 11.6x1.5



▲ VarioComp filling  
compound

# 2 PRECONDITIONS

## 2.1 Warranty conditions

If installed or commissioned incorrectly, all claims on the basis of the manufacturer's warranty and guarantee become void.

This brochure (version dated 8/2024) is intended for authorised qualified personnel and constitutes part of our warranty!

All previous versions become invalid upon release of a new version! For the latest version please refer to the QR Code on the title page or [www.variotherm.com](http://www.variotherm.com).

Local, geographic and climatic regulations/standards for cooling, heating and electrical installations must be observed!

## 2.2 Information on standards

The validity of the standards referred to in these installation instructions was last checked on 22.08.2024. If necessary, amendments to standards must be checked.

## 2.3 Coordination of the floor structure

The following items must be coordinated between the architect, construction manager, installation technician and floor layer:

- › Horizontal level
- › Floor structure with:
  - appropriate strength
  - the necessary vapour retarders/barriers
  - the necessary thermal/impact sound insulation
- › Expansion joints
- › VarioComp filling compound to be applied by installer, floor layer or construction manager.
- › Floor covering, with heat sensors if necessary

## 2.4 Vapour barrier/vapour retarder

Vapour barriers or vapour retarders need to be included in the floor structure, depending on the installation situation and type of floor covering. An agreement must be reached in a coordination meeting between the contractors (construction company, installation technician, etc.) as to whether these intermediate layers are necessary.

## 2.5 Rooms

- › The rooms must be cleared out, clean, grease-free, dust-free and dry. Residual plaster and mortar must be removed.
- › To prevent the VarioComp filling compound from drying out too quickly, there must be no draughts on the construction site (windows, exterior doors and door frames should be installed).
- › All trades involved must be informed about the installation of the floor heating, and no other work may be conducted while the heating is being laid in order to ensure that no damage occurs during the subsequent installation work. If necessary, a warning sign should be hung up at a suitable place on the construction site. Warning signs are available from [www.variotherm.com](http://www.variotherm.com) (Service/Info centre).

## 2.6 Tools

Recommended tools (at the construction site) for the installation work:



Vacuum cleaner



Rubber mallet

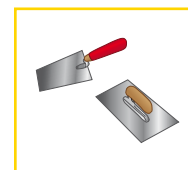

Trowel

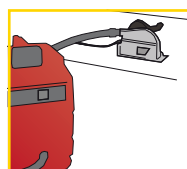

Circular saw or jig saw

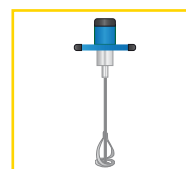

Agitator

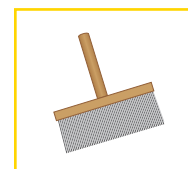

Brush or paintbrush for cleaning

Variotherm tools for applying the VarioComp filling compound:

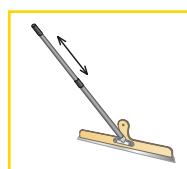

Scraper



Bucket set

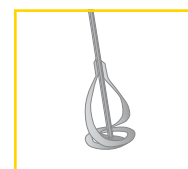

VarioComp mixing tool



## 2.7 Movement joints

Movement joints (e.g. with edge insulation strips) are required in order to allow for expansion. These are to be defined by the architect or planner.

- › Field size max. 80 m<sup>2</sup>, lateral length max. 12 m  
Building joints must be continued throughout the entire floor structure up to and including the floor covering.
- › Keep the number of pipe feed-throughs through the movement joints to a minimum.

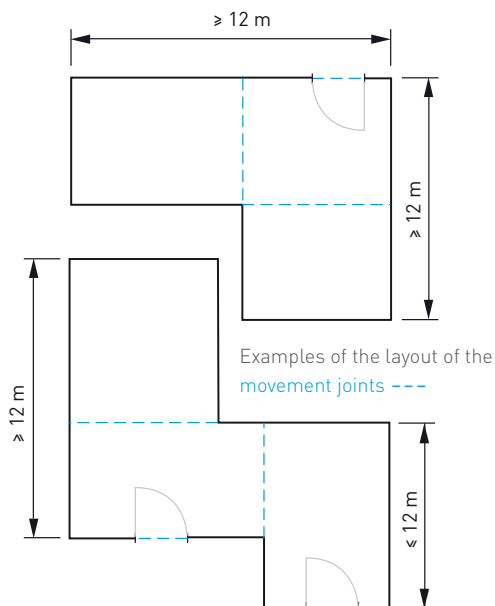

Movement joints are particularly important when it comes to ceramic floor coverings. It is crucial that the movement joints run congruently in all layers (compact floor heating and floor covering). See Chapter 4.5 for details on pipe laying with movement joints.

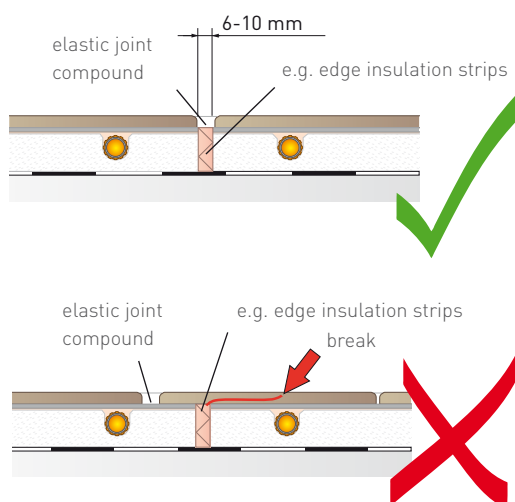

## 2.8 Humidity

The maximum air humidity may not exceed 70 % during storage, installation and further processing of the VarioComp boards, and during the construction phase and use of the building. Wet plaster and wet screed must be applied and dried before the VarioComp boards are installed.

The VarioComp boards may be used in rooms up to humidity class W3 as specified in ÖN B 3407 [or W1-I as specified in DIN 18534-1].

## 2.9 Transport/storage of goods

### VarioProFile pipe

Leave the VarioProFile pipe in the box for as long as possible in order to avoid damage such as dents and scratches. This type of damage has a detrimental effect on the creep behaviour.

In order to prevent damage to the VarioProFile pipe during the construction phase, high-visibility warning signs should be placed at appropriate locations.

The interaction of the oxygen in the air with UV rays damages the VarioProFile pipes, which should not be stored in the open air.

At low temperatures ( $\leq 5$  °C) the VarioProFile pipe should be stored in heated rooms prior to installation.

### VarioComp boards

The VarioComp boards are delivered on pallets. When storing, ensure that there is sufficient load-bearing capacity at the storage site. The VarioComp boards should always be stored flat on an even surface. They should be protected from moisture, particularly rain. Boards that have become damp for a brief period of time may only be processed after they have dried out completely. Always store the VarioComp boards with the routings facing upwards.

### VarioComp filling compound

The VarioComp filling compound is delivered in sacks on pallets. It must be ensured that they are stored in a dry place and covered in foil until they are used. The maximum length of storage is 12 months from the production date (see stamp on the bag). For safety data sheet, go to [www.variotherm.com](http://www.variotherm.com) (Service/Info centre).

## 2.10 Impact sound insulation

Particular attention should be paid to impact sound insulation. The impact sound improvement values must be specified by the planner or architect and be coordinated with the relevant floor structure as described in Chapter 3. See also chapter 4.3 for Variotherm SILENT underlay board.

# 3 FLOOR STRUCTURE

## 3.1 General

The VarioComp board is a pure tube carrier and thermal conduction element - and should therefore be regarded as a floor covering and not as a component of the floor structure. Why? The necessary static support, thermal and impact sound insulation and protection against moisture diffusion must already be provided by the construction underneath the VarioComp board.

The following items must be coordinated between the architect, construction manager, installation technician

and floor layer:

- > Horizontal level line
- > Floor structure with appropriate strength, necessary vapour retarders/barriers, necessary thermal insulation/impact sound insulation and expansion joints
- > VarioComp filling compound to be applied by installer, floor layer or construction manager
- > Floor covering, with heat sensors if required

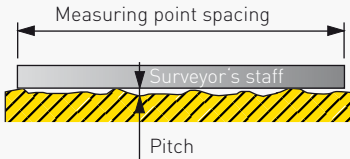
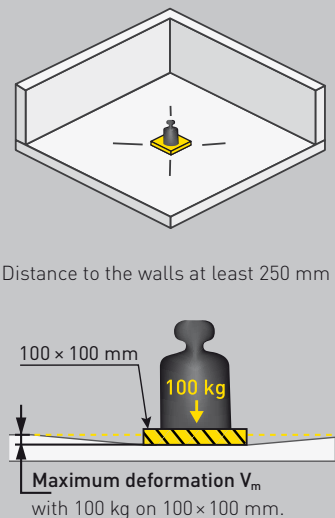
1. DRY	2. LEVEL	3. LOAD-BEARING																
<p>The substrate must be dry, dust and grease free. Maximum residual humidity of the subsurface (CM values):</p> <ul style="list-style-type: none"> <li>• Untreated concrete: 3.0 %</li> <li>• Cement screed: 2.0 %</li> <li>• Calcium sulphate screed: 0.5 %</li> </ul>	<p>The required evenness is as follows (ÖNORM DIN 18202):</p> 	 <p>Distance to the walls at least 250 mm</p> <p>100 × 100 mm</p> <p>100 kg</p> <p>Maximum deformation <math>V_m</math> with 100 kg on 100 × 100 mm.</p>																
<table border="1" style="margin: auto;"> <thead> <tr style="background-color: #ffc107;"> <th colspan="4">Measuring point spacing</th> </tr> <tr style="background-color: #d3d3d3;"> <th>0.1 m</th> <th>1 m</th> <th>4 m</th> <th>10 m</th> </tr> </thead> <tbody> <tr> <td>1 mm</td> <td>3 mm</td> <td>9 mm</td> <td>12 mm</td> </tr> <tr style="background-color: #ffc107;"> <td colspan="4" style="text-align: center;">Maximum pitch</td> </tr> </tbody> </table>	Measuring point spacing				0.1 m	1 m	4 m	10 m	1 mm	3 mm	9 mm	12 mm	Maximum pitch					
Measuring point spacing																		
0.1 m	1 m	4 m	10 m															
1 mm	3 mm	9 mm	12 mm															
Maximum pitch																		
<p>The load-bearing capacity specified in the table below must be provided. If there are several concentrated loads, these must be at least 500 mm apart.</p> <p><b>Caution:</b> The sum of the concentrated loads must not exceed the maximum permissible floor load capacity. Particularly heavy objects (pianos, aquariums, bathtubs) must be given special consideration!</p>																		
Room usage examples in accordance with ÖNORM EN 1991-1-1	Max. concentrated load $Q_k$	Max. service load $q_k$	Max. deformation $V_m$ (with 100 kg on 100 × 100 mm)															
<p><b>Category A1:</b> Floors of rooms in residential buildings and houses, wards and hospital rooms (without heavy diagnostic instruments), rooms in hotels and lodgings, kitchens, toilets and rooms with residential-type use in existing buildings</p> <p><b>Category B1:</b> Office floors in existing buildings</p>	2.0 kN	2.0 kN/m <sup>2</sup>	1.5 mm															
<p><b>Category B2:</b> Office floors in office buildings</p> <p><b>Category C1:</b> Floors in rooms with tables etc., e.g. classrooms in schools, cafés, restaurants, dining areas, reading rooms, reception rooms, wards and hospital rooms (with heavy diagnostic instruments)</p>	3.0 kN	3.0 kN/m <sup>2</sup>	1.0 mm															
<p><b>Category C2:</b> Floors in rooms with fixed seating, e.g. in churches, theatres, cinemas, conference rooms, lecture halls, meeting halls, waiting rooms, train station waiting rooms</p>	4.0 kN	4.0 kN/m <sup>2</sup>	Consultation is necessary															

### 3.2 Usual substructures

**Screed / Bare slab**

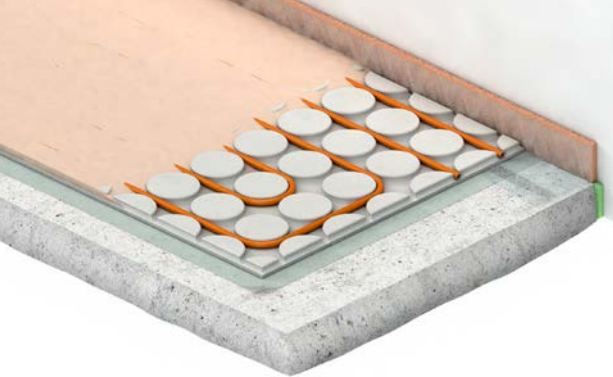

Screed:

- › Test for evenness, and if necessary, even out using levelling compound.
- › Test for dryness.

Bare slab:

- › Test for evenness, and if necessary, even out using levelling compound.
- › Building sealant, if required.

**Wooden beam ceiling**



- › Check sagging, surface evenness and load-bearing capacity (see e. g. max. deformation  $V_m$ , Chapter. 3.1); reinforce construction if required

**Fill /Dry construction**

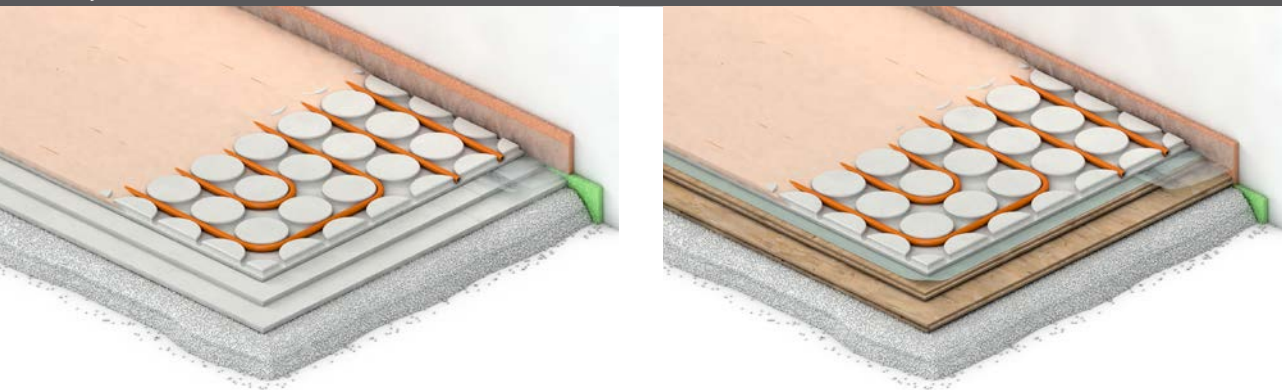

Fill

- › Loose fill (necessary compaction must be provided!)
- › Bonded fill (oven dry density  $350 \text{ kg/m}^3$ , compression strength  $0.4\text{--}0.5 \text{ N/mm}^2$ )
- › Trickle protection sheet, if required

Load distribution layer<sup>1</sup> needed! e.g.

- › 20 mm dry screed element, processing according to manufacturer's instructions
- › 2 × 15 mm OSB board, glued and screwed
- › 2 × 19 mm chipboard (V100), glued and screwed

<sup>1</sup> The load distribution layers are given as examples. VarioComp boards, XPS and other insulation boards are not suitable as load distribution layers!

### VarioComp boards on thermal/impact sound insulations up to 30 mm thickness

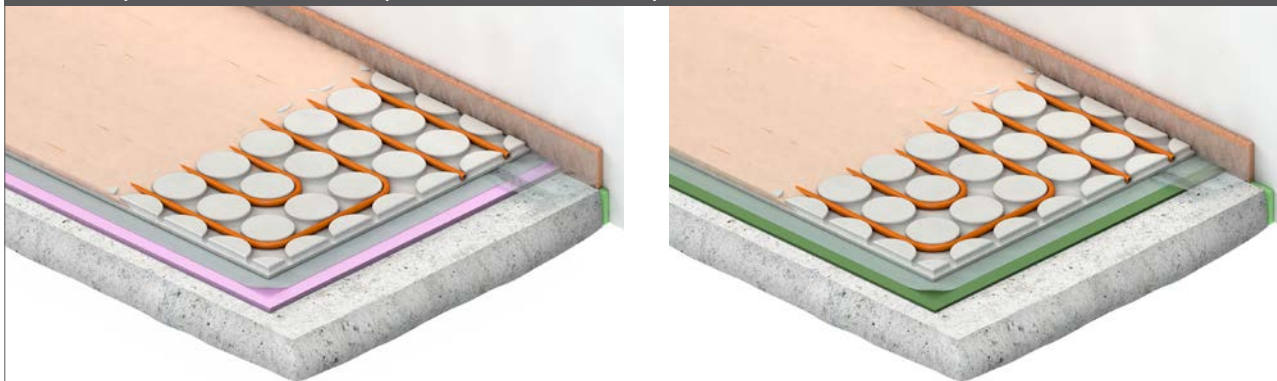

The VarioComp board can be laid directly on thermal/impact sound insulations up to an insulation thickness of 30 mm. The requirement is for a sufficiently high compressive strength of the underlay boards:

#### Insulation thickness max. 15 mm and compressive stress (at 10 % compression) $\geq 150$ kPa (15 t/m<sup>2</sup>)

- > 5 mm: Variotherm SILENT underlay board, 1 layer
- > 10 mm: Variotherm SILENT underlay board, 2 layers (staggered) or
- > 10 mm: Variotherm XPS underlay board, 1 layer
- > 15 mm: Variotherm XPS+SILENT underlay boards (staggered)

<< For details see chapter 4.3

#### Insulation thickness max. 20 mm and compressive stress (at 10 % compression) $\geq 200$ kPa (20 t/m<sup>2</sup>)

- > Variotherm XPS underlay boards, 2 layers (staggered)

#### Additional product examples:

Ardex DS 40	Gutex Multiplex-top	PCI (BASF) Polysilent	Unifloor Jumpax CP/Heat-Pak
Austrotherm Universalplatte	Jackon Jackodur KF 300 Standard GL	PCI (BASF) Pécidur	Unifloor Heat-Foil
Austrotherm Uniplatte	Jackon Jackoboard	Styrodur 2800C	Unifloor Redupax/Redupax+
DOW Styrofoam LB-A/LBH-X/RTM-NC-X	DOW Floormate 200-A	Wedi building board	

#### Insulation thickness max. 30 mm and compressive stress (at 10 % compression) $\geq 300$ kPa (30 t/m<sup>2</sup>)

#### Product examples:

Austrotherm XPS Top 30	Jackon Jackoboard	PCI (BASF) Polysilent	Unifloor Jumpax CP/Heat-Pak
DOW Floormate 500-A	Jackon Jackodur KF 300 Standard GL	PCI (BASF) Pécidur	Wedi Bauplatte
DOW Styrofoam LB-A/LBH-X/RTM-NC-X	Kingspan GreenGuard GG300	Styrodur 3000 CS/SQ	Foamglas T4+

### VarioComp boards on thermal/impact sound insulations<sup>1</sup> starting from 30 mm thickness

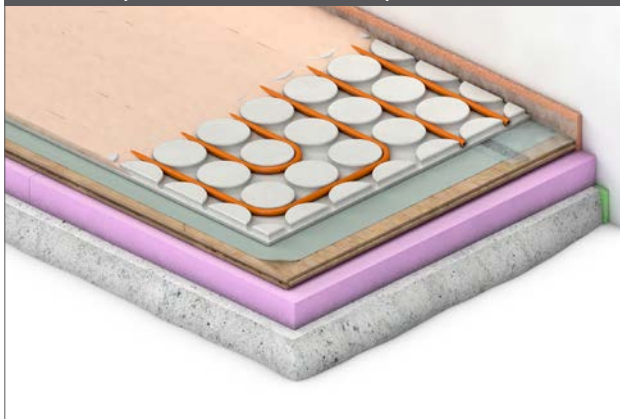

For laying on thermal/impact sound insulations<sup>1</sup> starting from 30 mm, a load distribution layer<sup>2</sup> is additionally needed! e.g.:

- > 18 mm OSB board, tongue and groove bonded
- > 19 mm chipboard (V100), tongue and groove bonded
- > 25 mm dry screed element, processing according to manufacturer's instructions
- > 2 × 15 mm OSB board, glued and screwed
- > 2 × 19 mm chipboard (V100), glued and screwed

<sup>1</sup> The insulation below the load distribution layer must be sufficiently stable for walking, and must be approved for floor constructions by the manufacturer.

<sup>2</sup> The load distribution layers are given as examples. VarioComp boards, XPS and other insulation boards are not suitable as load distribution layers.

Note: 0.1 N/mm<sup>2</sup> = 100 kN/m<sup>2</sup> = 100 kPa = 10 t/m<sup>2</sup>; 1 kN ≈ 100 kg



# 4 COMPONENTS & PROCESSING

## 4.1 Edge insulation strip

The edge insulation strip must allow a movement of the floor heating of at least 5 mm.

It is glued along the surrounding walls, as well as on pillars, steps, door frames, columns, shafts, etc. using the downwards aligned butyl rubber adhesive strip **a** before the floor heating is laid.

The edge insulation strip should extend from the load-bearing substrate (or the lower edge of the uppermost insulation layer) through to the upper edge of the floor cover.

If this is not possible due to the construction, the edge insulation strip must at least reach from the lower edge of the VarioComp board to the upper edge of the covering.

The overlap foil of the edge insulation strip is glued to the construction foil laid at a later stage using the applied adhesive strip.

The protruding remainder of the edge insulation strip is only removed after the floor covering has been completed.

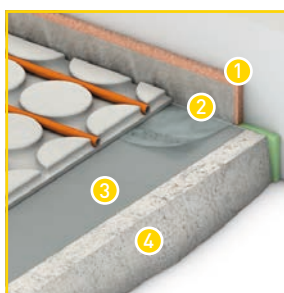
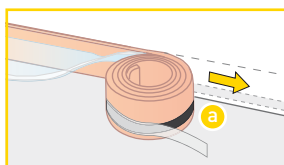

- 1 Edge insulation strip with
- 2 Overlap foil
- 3 PE construction foil
- 4 Load-bearing substrate

## 4.2 PE construction foil

The construction foil acts as a sliding and decoupling layer between the VarioComp board and the substrate. If dry screed gypsum fibre board has been applied below the VarioComp board, no construction foil is needed.

- > Before the VarioComp boards are laid, **the construction foil is laid** underneath covering the entire load-bearing substrate with an overlap of 30 mm and fastened with adhesive tape.
- > The load-bearing substrate (as described in Chapter 3) must be clean, dry and dust-free in order to prevent unevenness between the VarioComp boards later on.
- > In the edge areas, the construction foil **is glued** underneath to the overlapping foil of the edge insulating strip (self-adhesive strip).

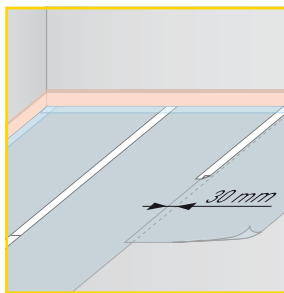
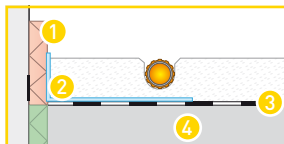

- > Edge insulation strip
- > Part No.: V299
- > PKU: 25 m roll
- 16 rolls in a bag
- > Weight/PKU: 0.8 kg
- > Material: PE foam
- > 75 mm high, 10 mm thick
- > Complies with EN 1264-4

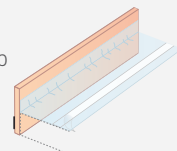

- > PE construction foil
- > Part No.: V2895
- > PKU: 50 m<sup>2</sup> roll
- > Weight/PKU: 5.1 kg
- > Thickness 0.1 mm
- > Material: recycled PE
- > Dimension:  
1030 mm × 50 m = 51.5 m<sup>2</sup>
- > Usable area:  
1000 mm × 50 m = 50.0 m<sup>2</sup>  
(with a 30 mm overlap)

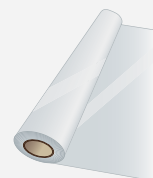

- > Adhesive tape
- > Part No.: V288
- > PKU: 1 pce. | Carton with 36 pcs.
- > Weight/PKU: 210 g
- > Roll: 50 mm × 66 m



- > VarioComp underlay board XPS
- > Part No.: V2898
- > PKU: 0.75 m<sup>2</sup> board
- > Package with 30 m<sup>2</sup>
- > Weight/PKU: 250 g
- > Perfect as thermal insulation

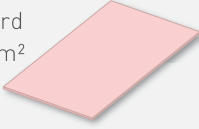

- > VarioComp underlay board SILENT
- > Part No.: V2899
- > PKU: 0.466 m<sup>2</sup> board
- > Package with 7 m<sup>2</sup>
- > Weight/PKU: 600 g
- > Perfect as impact sound insulation



- > VarioComp board
- > Pipe spacing 100 mm
- > Part No.: V290
- > PKU: 0.6 m<sup>2</sup> board
- > Pallet with 30 m<sup>2</sup> (50 pcs.)
- > Weight/PKU: 9.6 kg
- > 1000 × 600 × 18 mm

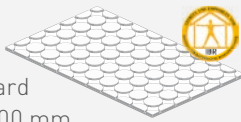

- > VarioComp board
- > Pipe spacing 150 mm
- > Part No.: V295
- > PKU: 0.54 m<sup>2</sup> board
- > Pallet with 27 m<sup>2</sup> (50 pcs.)
- > Weight/PKU: 9.6 kg
- > 900 × 600 × 18 mm

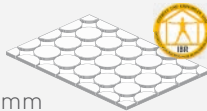

- > Blank board
- > Part No.: V021-029
- > PKU: 0.6 m<sup>2</sup> board
- > Pallet with 30 m<sup>2</sup> (50 pcs.)
- > Weight/PKU: 12.6 kg
- > 1000 × 600 × 18 mm



### 4.3 Compact underlay boards

As an option, the VarioComp underlay boards can be laid underneath the VarioComp modular floor heating system. They are the ideal supplement between non-insulated substrates (such as even screed) and the compact floor heating system.

#### Technical data

	XPS	SILENT
<b>Board dimensions</b>	1250 × 600 mm	790 × 590 mm
<b>Board thickness</b>	10 mm	5 mm
<b>Maximum board layers (Joint offset ≥ 200 mm)</b>	2	2
<b>Thermal conductivity [λ]</b>	0.035 W/mK	0.07 W/mK
<b>Thermal insulation resistance [R]</b>	0.286 m <sup>2</sup> K/W	0.071 m <sup>2</sup> K/W
<b>Impact sound reduction<sup>1</sup> [ΔL<sub>w</sub>]</b>	14 dB	17 dB
<b>Edge formation</b>	Straight edges	Blunt
<b>Surface</b>	Smooth	Smooth
<b>Board material</b>	Extruded rigid polystyrene foam (XPS)	Wood fibre insulation board as per EN 13986 and EN 622-4
<b>Compression strength or compression stress at 10% compression [CS(10%)]</b>	200 kPa (20 t/m <sup>2</sup> )	150 kPa (15 t/m <sup>2</sup> )
<b>Fire resistance as per EN 501-1</b>	E	E

<sup>1</sup> measured on bare reinforced concrete ceiling

### 4.4 VarioComp boards/blank boards

VarioComp boards from Variotherm are 18 mm gypsum fibre boards that are certified regarding their ecological properties. They consist of gypsum, cellulose and water, all of which are natural resources. Cellulose is manufactured from 100% waste paper. Different mixtures (types of paper, cardboard) are created, depending on the paper collected in the local region. This can lead to differences in board colour.

The VarioComp boards are used to hold the pipes and as a thermally conductive board for pipe spacing of 100 mm or 150 mm (pipe spaces of 150 mm are not recommended for living and barefoot areas!).

The blank boards are also 18 mm gypsum fibre boards that are certified regarding their ecological properties, but do not have grooves. They are used instead of VarioComp boards for small, unheated areas, e.g. food cupboards or areas with fixed installations.

Lifting, carrying and laying **individual** VarioComp boards:



Lifting, carrying and laying **multiple** VarioComp boards (5 boards and upwards):



First lower the VarioComp boards onto one edge and then lower them completely. Vertical storage leads to deformation of the boards and damage to the edges. It is possible to transport the boards horizontally inside the building with a lift truck or other board transportation vehicle.

- > The mean daily relative humidity must not exceed 70 % when laying the VarioComp boards. Wet plaster and wet screed must be applied and dried before the VarioComp boards are installed.
- > The load-bearing subsurface (as described in Chapter 3) must be clean, dry and dust-free.
- > The VarioComp boards are laid lengthways or crossways, with an offset of at least 200 mm, edge to edge.

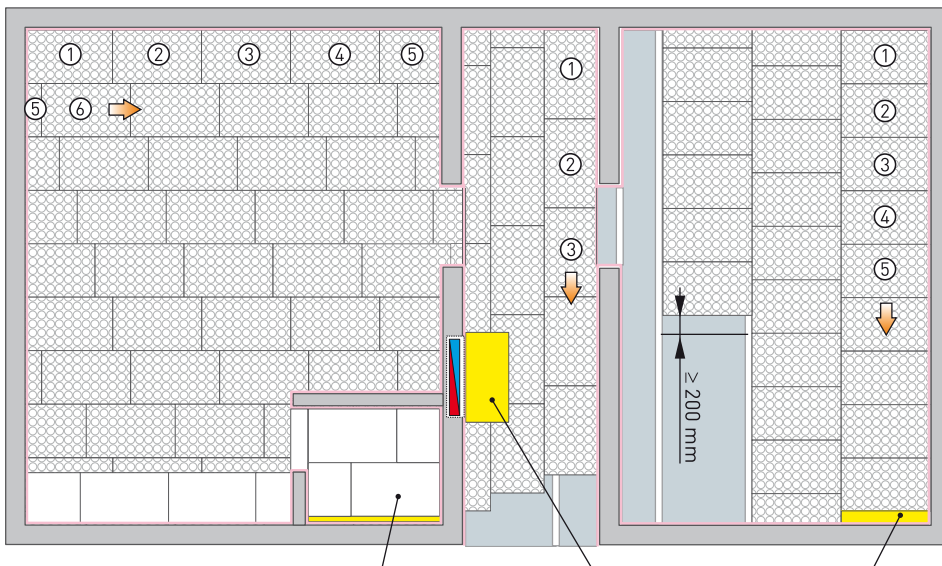

Blank boards for small, unheated areas, e.g. food cupboards or areas with fixed installations, instead of VarioComp boards.

Small residual surfaces and areas in front of the distribution manifold can be filled with the VarioComp filling compound.

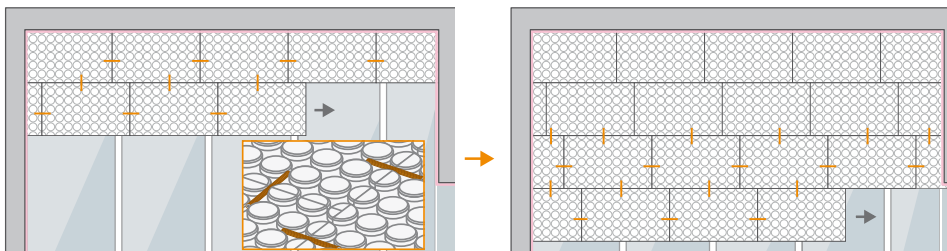

### Distribution manifold area

Depending on the size of the distribution manifold, a high pipe density possibly cannot be fitted into the VarioComp board anymore. It is therefore recommended to leave out the VarioComp board(s) in this area. It helps to have an aid in levelling the filling compound to the correct level later. Ideally, this aid consists of unused/residual pieces of VarioComp boards or blank boards.

The pipes can be affixed to the base using the VarioRail 11.6. Alternatively, you can use a perforated strip (avoid squashing the pipes!)

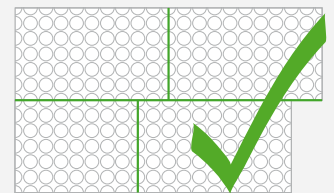
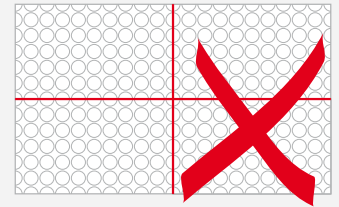
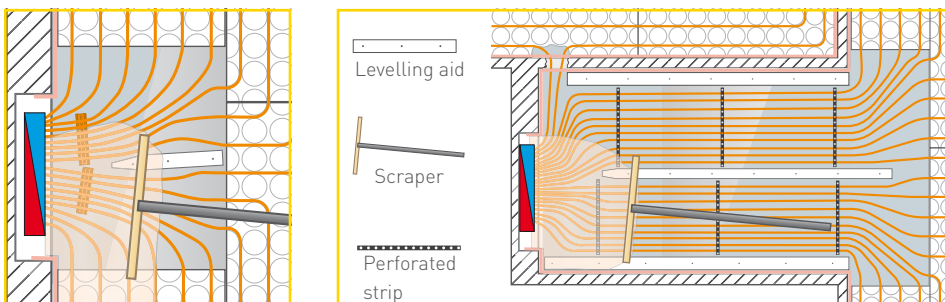

<< **Tip from Variotherm:** Align the rows of grooves with approx. 200 mm long pipe pieces!



- > VarioRail 11.6
- > Part No.: V2722
- > PKU: 1 m | Carton with 50 × 1 m
- > Weight/PKU: 100 g
- > Material: PE
- > Installation height: 17 mm
- > Grid spacing: 38.5 mm

<< For information on how to apply the VarioComp filling compound, see Chapter 4.7

## 4.5 VarioProFile pipe 11.6x1.5

- 1 Heat stabilized polyethylene (PE) with profiled surface structure
- 2 Adhesive layer
- 3 Homogeneous and solid aluminium pipe
- 4 Adhesive layer
- 5 Raised-temperature-resistance polyethylene (PE-RT)

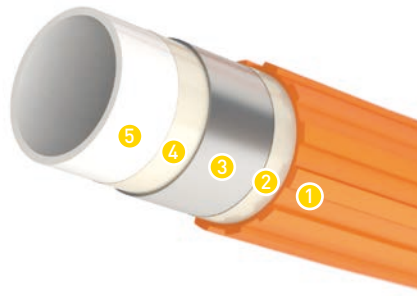

- > Part No.: VP116-100
- > PKU: 100 m roll | 18 rolls on pallet
- > Weight/PKU: 7.0 kg
- > Part No.: VP116-300
- > PKU: 300 m roll | 12 rolls on pallet
- > Weight/PKU: 18.0 kg
- > Part No.: VP116-500
- > PKU: 500 m roll | 8 rolls on pallet
- > Weight/PKU: 30.0 kg
- > Part No.: VP116-800
- > PKU: 800 m roll | 5 rolls on pallet
- > Weight/PKU: 44.8 kg

### Advantages

- > Fully corrosion-free
- > As light as a plastic pipe
- > 10-year guarantee with certificate
- > Optimum creep behaviour
- > Profiled surface structure guarantees optimum heat transfer (10 % larger surface)
- > Flexible, easy to bend, extremely stability
- > Resistant to hot water additives (inhibitors, antifreeze)
- > Mirror-smooth inner surface – less pressure loss – no encrustation
- > High pressure and temperature resistance
- > 100 % oxygen diffusion-tight
- > Lower linear coefficient of expansion, lower heat expansion forces
- > Tested as per EN 21003



### Technical data

- > Pipe diameter: 11.6 mm
- > Pipe wall thickness: 1.5 mm
- > Aluminium pipe thickness: 0.15 mm
- > Roll length: 100, 300, 500 and 800 m
- > Water content: 0.058 l/m
- > Special narrow bending radius (use a suitable bending device): 30 mm
- > Max. operating temperature [t<sub>max</sub>]: 70 °C
- > Short-term resistant [t<sub>ma</sub>]: 95 °C
- > Max. operating pressure [p<sub>max</sub>]: 6 bar
- > Linear expansion coefficient:  $2.3 \times 10^{-5} [K^{-1}]$
- > Mean heat conduction coefficient [λ]: 0.44 W/mK
- > Heat transmission resistance: 0.0034 m<sup>2</sup>K/W

### Elongation

with 10 m and temperature difference Δt 25 °C (e.g. 20 °C to 45 °C):

	Pipe material	Elongation
Plastics	PEX/VPE	50.00 mm
	PP	42.50 mm
	PB	32.50 mm
	PVC	20.00 mm
	VarioProFile pipe	5.75 mm
Metal	Cu	4.20 mm
	Stainless steel	3.50 mm
	Steel	2.88 mm

### Creep behaviour

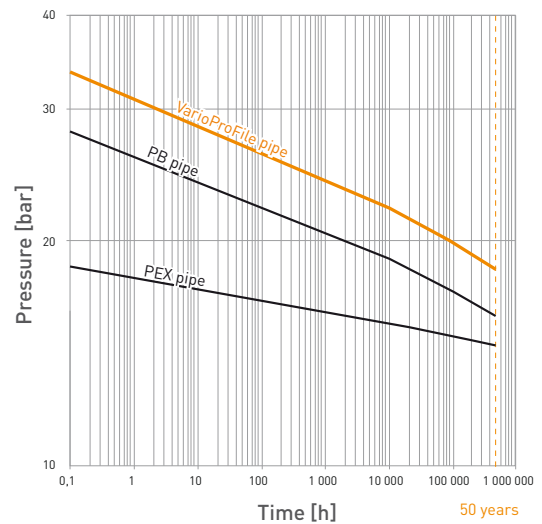

Homogeneous plastic pipes produce high stress levels in the device because of their expansion coefficient.

The VarioProFile pipe is ideal for use as a surface heating and cooling pipe due to the very small changes in length and thermal expansion force.



## Installation

The spacing between the pipes during laying depends on the thermal capacity needed for the individual rooms:  
 100 mm: living spaces and barefoot areas  
 150 mm: e.g. workshops, halls, office spaces, etc. (not recommended for living spaces and barefoot areas!)

	Pipe requirement	
	100 mm pipe spacing	10 m/m <sup>2</sup>
150 mm pipe spacing	6.7 m/m <sup>2</sup>	

	Maximum 11.6 mm VarioProFile pipe length per heating circuit
	<b>80 m</b> (pay attention to the pump design!)

- > Do not make any kinks in the pipe!
- > With a room temperature of over +5 °C, the pipes can be bent manually without pre-warming.
- > Check that the grooves are clean! Dirt particles prevent flush laying of the pipes and can cause pipe damage.
- > As pipe length guide, there are marks on every metre on the VarioProFile pipes (e.g. >I< 127 m )
- > Lay without twisting, and use a pipe uncoiler.
- > Press the VarioProFile pipe between the routings using the sole of your shoe. When changing direction, guide the pipes around the routings with your thumb.
- > After the heating circuit is completed, the VarioProFile pipe is returned to the heating manifold, cut off at the appropriate length, calibrated, and connected.

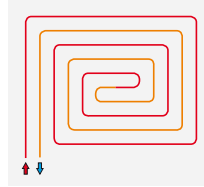

**Spiral:**  
 Uniform distribution of surface temperature as the supply is located next to the return.

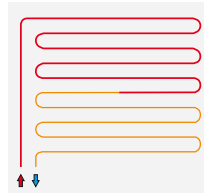

**Meandering:**  
 Less uniform distribution of surface temperature, for small, ancillary rooms and peripheral zones.

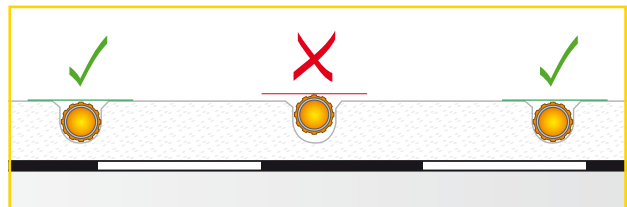
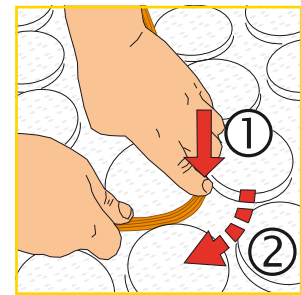
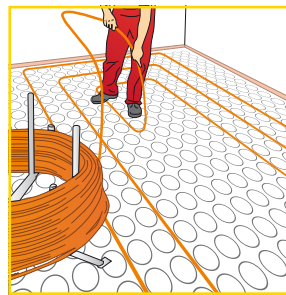
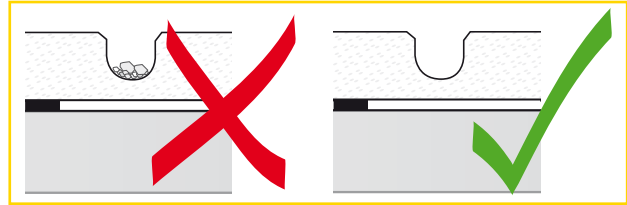

## Pipe installation at movement joints

For preparation of movement joints, also see chapter 2.7.

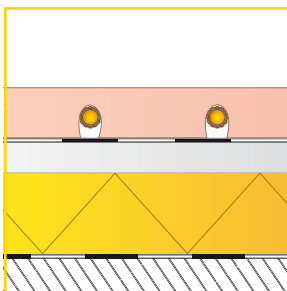

▲ Pipe feed-through through the movement joint (no sleeve tube required)

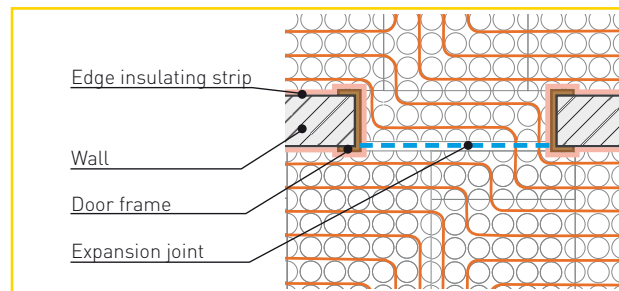

▲ In the vicinity of the door, the expansion joint is fed through under the door leaf. Variant 1: Door area fitted with VarioComp board

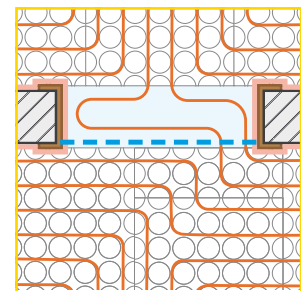

▲ Variant 2: Later, only use VarioComp filling compound to fill in the door area.

Laying example of a private single-family private house (ground floor)

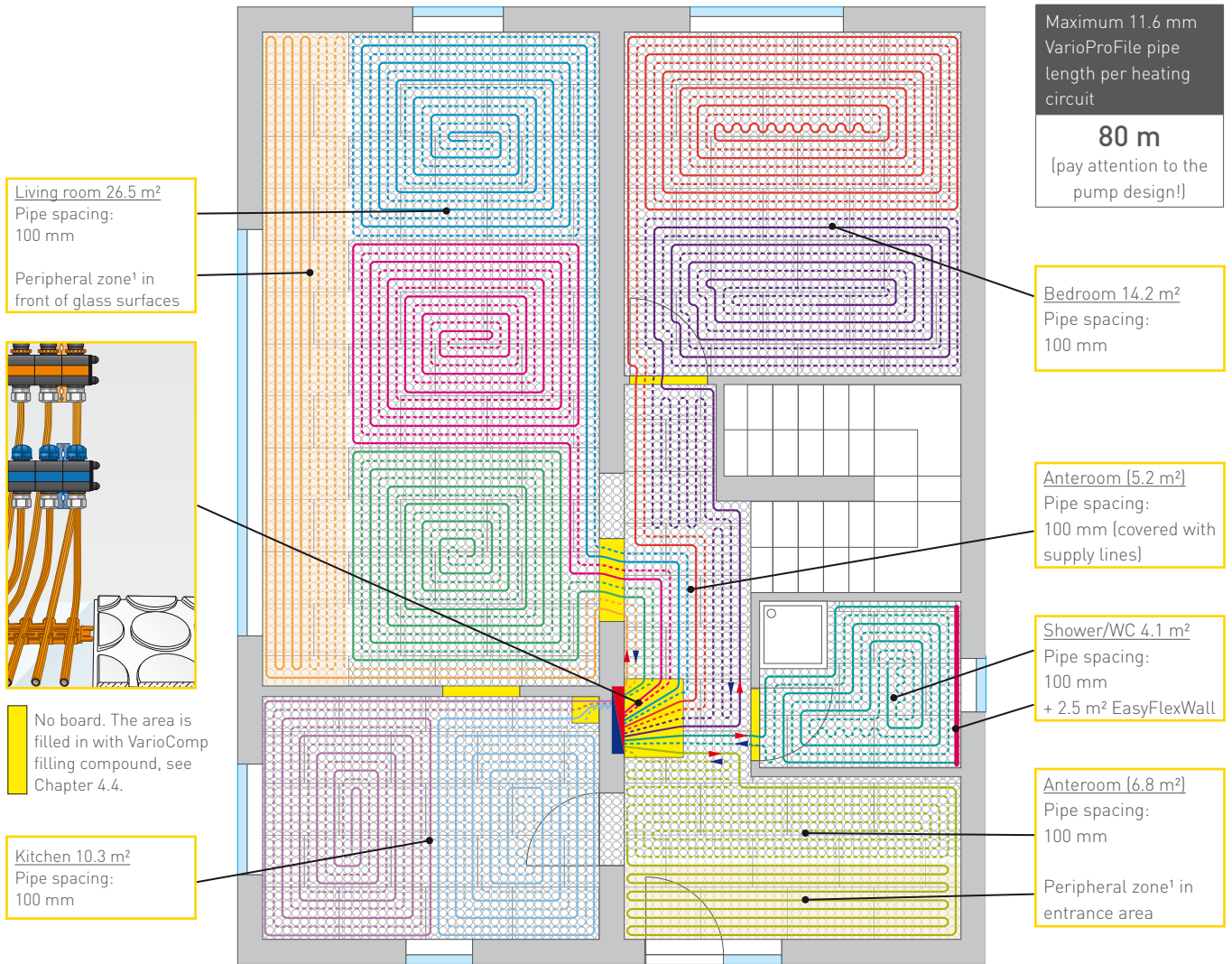

<sup>1</sup> Peripheral zone: Starting in front of a large glass surface or glass doors, a meander pattern layout goes along the glass surface, reaching into the room by about 1 metre. This will lead to a higher surface temperature in front of the glass surfaces (Variotherm comfort tip).

Check



## Calibrating/pressing the pipe

For processing residual pipe lengths or for repairs, the VarioProFile pipes 11.6x1.5 can be permanently and securely connected to each other using a press-fit coupling 11.6x11.6. The press-fit coupling must lie completely at the VarioComp board level. A permanent, secure connection is only guaranteed if original Variotherm system components are used:

- > VarioProFile pipe 11.6x1.5
- > Variotherm calibration and chamfering tool
- > Variotherm press-fit couplings and Variotherm pressing tool

The press-fitting pliers and drive unit must be checked at least once a year for correct operation by REMS or an authorised REMS customer service workshop.

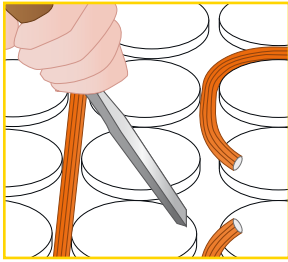

▲ Chisel out the groove

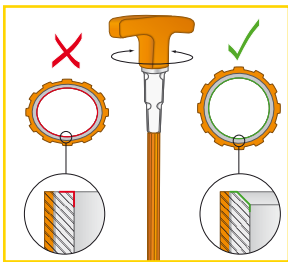
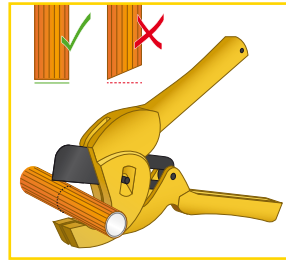
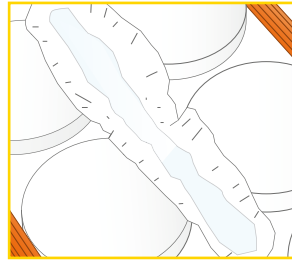

▲ Calibrate and chamfer the pipe

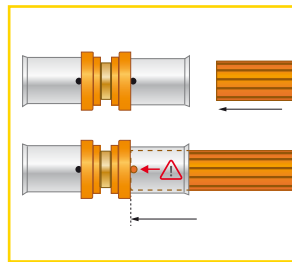

▲ Push on the press-fit coupling until it reaches the stop

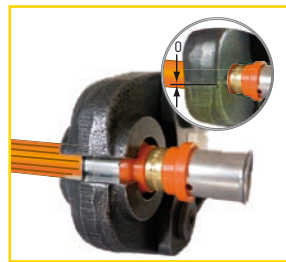

▲ Pressing. The press-fitting jaw must close fully.

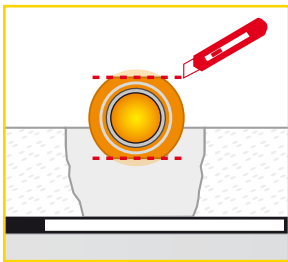

▲ Flatten / cut away the guide rings

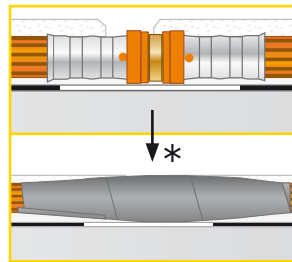

▲ Insert the pressed press-fit coupling\*

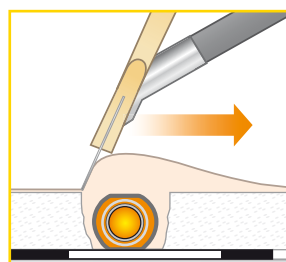

▲ For application of the filling compound, see Chapter 4.7

\*Corrosion prevention measures: The connecting elements are to be protected (after the pressure test) in accordance with EN 1264 and compliance with ÖN H 5155 (e.g. with Z1699 cold shrink tape).

The relevant operating instructions for the pressing tools are included with the appliances.

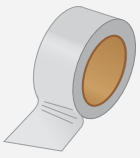

- > Cold shrinking tape
- > Part No.: Z1699
- > PKU: 1 pce. | Carton with 20 pcs.
- > Weight/PKU: 990 g
- > Roll: 50 mm x 15 m
- > 1 roll is sufficient for approx. 35 press-fit coupling connections (with a 50 % overlap)



- > Calibration and chamfering tool
- > Part No.: W042
- > PKU: 1 pce.
- > Weight/PKU: 140 g
- > For calibrating and chamfering the Variotherm pipes



- > Pipe cutting pliers
- > Part No.: W037
- > PKU: 1 pce.
- > Weight/PKU: 230 g
- > For trimming the Variotherm pipes
- > Replacement blade: W0371

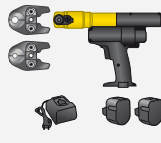

- > AkkuPress Mini
- > Part No.: W019
- > PKU: 1 pce.
- > Weight/PKU: 9.9 kg
- > Incl. sheet steel box, press-fitting jaws TH16 Mini & TH11.6 Mini, battery charger, 2 batteries



- > Mini press-fitting jaw TH11.6
- > Part No.: W031
- > PKU: 1 pce.
- > Weight/PKU: 1.5 kg

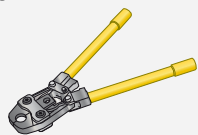

- > EcoPress
- > Part No.: W015
- > PKU: 1 pce.
- > Weight/PKU: 9.7 kg
- > Incl. sheet steel box, press-fitting jaws TH16 & TH11.6



- > Press-fitting jaw TH11.6
- > Part No.: W025
- > PKU: 1 pce.
- > Weight/PKU: 2.0 kg



- > Press-fit coupling 11.6x11.6
- > Part No.: Z1600
- > PKU: 1 pce.
- > Weight/PKU: 30 g
- > Press contour: TH[11.6]

## 4.6 VarioManifold / Pressure test

### Advantages

- › Plastic manifold with internal air chambers for thermal insulation
- › Flexible conversion to thermostat operation
- › Pre-settable flow indicator in the flow (10-160 l/h) according to EN 1264-4, viewing glass can be cleaned
- › Optimised for **low-temperature** surface heating/cooling
- › Detachable 3-way ball valves on the flow and return
- › Venting option, flushing option via rotatable fill and drain cocks
- › Modular construction
- › Absolutely oxygen-tight
- › Designation labels
- › All parts self-sealing, manifold pressure-tested
- › Variable distance between flow and return bars

### Pressure test

Once all circuits have been connected to the heating/cooling manifold, the system can be filled downstream of the manifold and pressurised. The pipes are to be kept under pressure prior to applying the VarioComp filling compound so that any damage becomes immediately visible. (Please see Chapter 7.1 for the protocol Leak-tightness test).

For details regarding the system and heating circuit pipes and the room temperature control please refer to the "DISTRIBUTION and CONTROL" planning and installation instructions



PDF



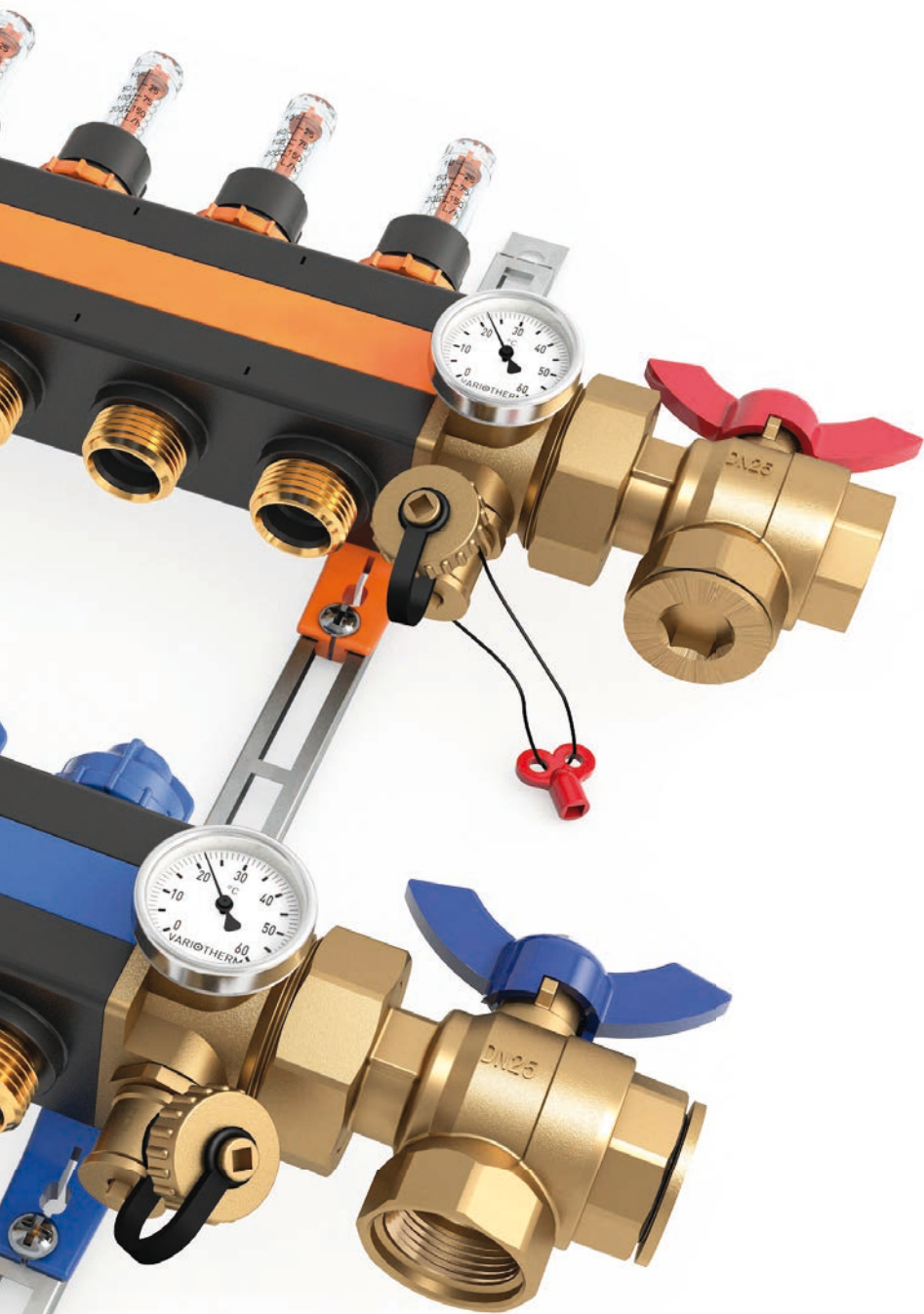

#### **Pumped VarioManifold**

The Pumped VarioManifold allows the integration of a low-temperature surface heating system (2 to 15 heating circuits) in a high-temperature heating system (2-pipe system) with existing circulation pump.



#### **Pump Microstation**

The Pump Microstation allows the integration of a low-temperature surface heating system (1 to 2 heating circuits) in a high-temperature heating system (2-pipe system) with existing circulation pump.

- > VarioComp filling compound T7
- > Part No.: V291
- > PKU: 1 bag
- 42 bags on pallet
- > Weight/PKU: 25 kg
- > Consumption:
  - approx. 6.0 kg/m<sup>2</sup> for V290 (pipe spacing 100 mm),
  - approx. 4.8 kg/m<sup>2</sup> mit V295 (pipe spacing 150 mm)
- > Special filling compound for filling out the laid VarioComp boards



**Technical data:**

Thermal conductivity  $\lambda_{10, dry, mat}$ :

0.61 W/(mK) [50 %-Quantil]

Diffusion resistance  $\mu$ :

approx. 15

Oven-dry density:

1450 kg/m<sup>3</sup>

Heat capacity cp:

approx. 1000 J/(kgK)

- > VarioComp mixing tool
- > Part No.: W030
- > PKU: 1 pce.
- > Weight/PKU: 715 kg
- > Diameter 120 mm
- > Drive unit recommendations:
  - 1000 W, 600 min<sup>-1</sup>,
  - Drill chuck  $\geq$  13 mm
- > For optimum processability of the VarioComp filling compound



- > Bucket set
- > Part No.: W028
- > PKU: 1 set
- > Weight/PKU: 1.2 kg
- > Water bucket for the correct dosage
- > 30 litre bucket for mixing the VarioComp filling compound

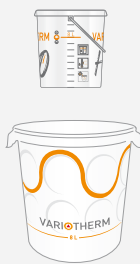

- > Scraper
- > Part No.: W029
- > PKU: 1 pce.
- > Weight/PKU: 1.0 kg
- > Scraper width 600 mm
- > With telescopic shaft
- > For evenly spreading the VarioComp filling compound

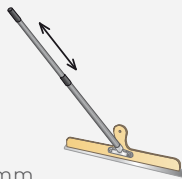

## 4.7 VarioComp filling compound T7

The VarioComp filling compound is a filling compound developed specially by Variotherm for filling the laid VarioComp boards. It guarantees the best possible thermal transfer of the VarioProFile pipe onto the entire VarioComp board.

The VarioComp filling compound is not self-levelling and is therefore evenly distributed and removed using a scraper.

Before pouring in the VarioComp filling compound, a pressure test should be carried out for all the relevant heating circuits. Use the log for this purpose [Chapter 7]. We recommend to keep the pipes under water pressure while pouring in the VarioComp filling compound. The processing temperature must be at least +5 °C.

### Manual application of the VarioComp filling compound

1. Dry, Dust-free, Grease-free. Temperature: +30 °C and +5 °C.
2. 8 L water added to bucket. Temperature: +15 °C and +5 °C.
3. 8 L filling compound added to bucket.
4. 25 kg filling compound added to bucket.
5. Mixing with max. 600 min<sup>-1</sup> for 1.5–2 min.
6. Pouring the mixture onto the laid boards.
7. Spreading the mixture. Pot life: 20–30 minutes.
8. Scraping the mixture to the level of the boards.
9. Scraping off at the level of the boards.
10. Pot life: 20–30 minutes. (Note: Empty bucket completely after every mixing process with a trowel and clean it with a paint brush.)
11. Drying times: ~ 1.5 h (ti = 20 °C) and ~ 2.5 h (ti = 10 °C).

<sup>1</sup> In order to prevent shortening of the pot life, empty the bucket completely after every mixing process with a trowel and clean it with a paint brush. >>

### Machine application of the VarioComp filling compound (recommended for large-scale projects)

The VarioComp filling compound can also be applied using a mixing pump. The time-consuming mixing with a bucket is no longer necessary as this is done in the machine. A third person is required for filling the machine with VarioComp filling compound.

As an example, Knauf PFT G4 ([www.pft.net](http://www.pft.net)):

- > Stator/Rotor D4-3 PIN Twister or D3-5 wf can be used as a mixing pump
- > Recommended water quantity approx. 6–12 l/min.
- > Geka coupling 1"AG/1"IG
- > Mixing spiral for heavy plaster

or similar products (e.g. M-Tec, Inotec, Ützener-UMS/Putzknecht)

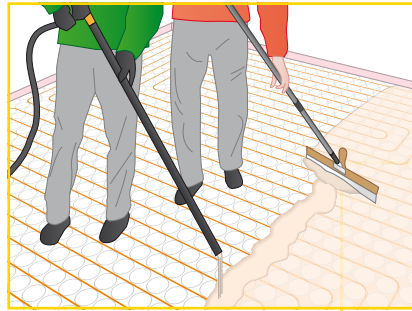

Knauf PFT G4  
© Knauf PFT



### Checking the applied VarioComp filling compound

As soon as it is possible to walk on the surface, the excess filling compound is removed using a trowel or plastering knife.

Note: The top of the VarioProFile pipe is flush with the level of the board surface and can be visible at several points!

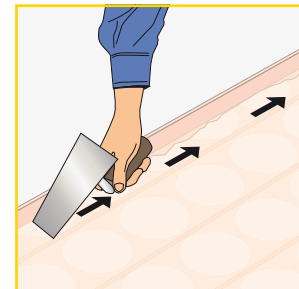
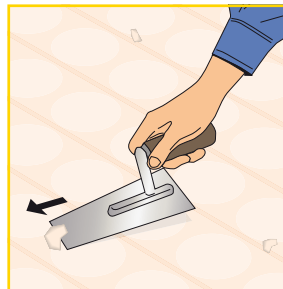

### Checking for evenness

The surface of the VarioComp corresponds to ÖNORM DIN 18202 (table 3, line 3), limits of evenness deviations (see also Chapter 5).

Special case: if according to the floor layer the standard tolerances are too high for laying the required floor covering, however, uneven areas can be evened out as follows:

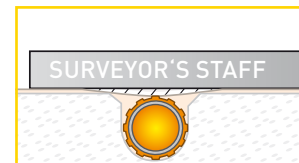

#### Option 1: Level out with a 2nd layer of VarioComp filling compound (levelling out up to max. 3 mm)

If the 1st layer of VarioComp filling compound is **not older** than 3 hours, a 2nd layer of VarioComp filling compound can be directly applied **without** a base coat.

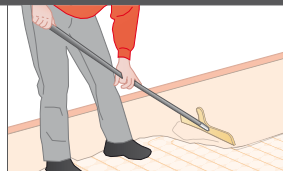

If the 1st layer of VarioComp filling compound is **older** than 3 hours, a 2nd layer of VarioComp filling compound can be applied **in combination with** a base coat. You may only apply the base coat once the VarioComp filling compound (0.3 % CM) has completely dried out. (See the table in Chapter 5.4 for suitable base coats)

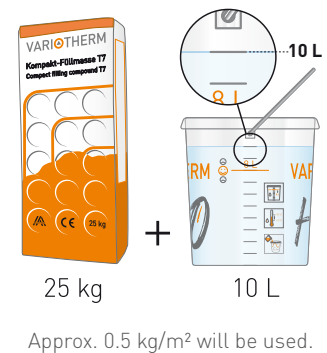

#### Option 2: Levelling out with a calcium sulphate levelling compound

1. Layer of VarioComp filling compound **with base coat** + calcium sulphate levelling compound. You may only apply the base coat once the VarioComp filling compound (0.3 % CM) has completely dried out.



See the table in Chapter 5.4 for examples of base coats and calcium sulphate levelling compounds.

# 5 FLOOR COVERING

## 5.1 General

It is not necessary and not permitted to abrade the surface of the finished VarioComp!

- › The floor covering used must be suitable for floor heating systems (observe the manufacturer's instructions).
- › The surface of the VarioComp complies with DIN 18202 (Table 3 – limits for evenness deviations, Row 3).
- › The tensile bond strength is 1 N/mm<sup>2</sup>
- › The floor covering should be laid as quickly as possible to avoid any soiling of the surfaces or damage to the pipes.
- › Floors should have a max. thermal resistance of 0.15 m<sup>2</sup>K/W. Variotherm recommends: ≤ 0.1 m<sup>2</sup>K/W (incl. underlay/adhesive)

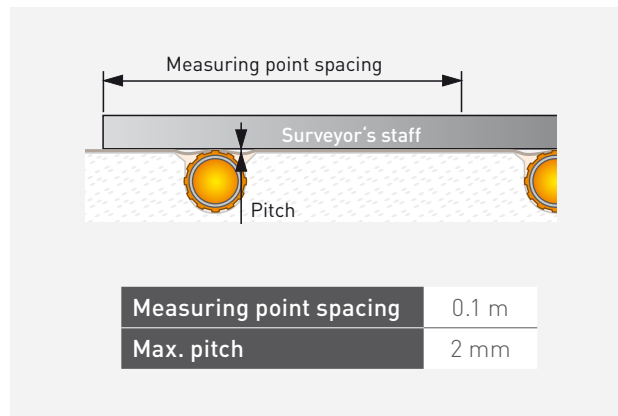

Guidelines for the thermal resistance R [m<sup>2</sup>K/W] of various floor coverings:

Floor covering	Thickness	Thermal resistance R = d/λ
Tiles	8 mm	0.01 m <sup>2</sup> K/W
Clinker slabs	11 mm	0.01–0.02 m <sup>2</sup> K/W
Marble	10 mm	0.01 m <sup>2</sup> K/W
Natural stone slab	12 mm	0.01 m <sup>2</sup> K/W
Linoleum	2,5 mm	0.015 m <sup>2</sup> K/W
PVC coverings	2,5 mm	0.01–0.02 m <sup>2</sup> K/W
Cork parquet	4 mm	0.05 m <sup>2</sup> K/W
Prefinished parquet floor (2-layer)	10 mm	0.05–0.07 m <sup>2</sup> K/W
Prefinished parquet floor (3-layer)	14 mm	0.07–0.10 m <sup>2</sup> K/W
Laminate	9 mm	0.05 m <sup>2</sup> K/W
Thin carpet	6 mm	0.07–0.11 m <sup>2</sup> K/W
Medium carpet	9 mm	0.11–0.15 m <sup>2</sup> K/W
Thick carpet	13 mm	0.15–0.24

## 5.2 Residual humidity of the VarioComp filling compound

The assessment of the readiness for covering is carried out via the calcium carbide method (CM). Before laying the floor covering, the VarioComp filling compound must be dried in accordance with the following table:

Floor covering (Take note of the manufacturer's instructions!)	CM value (remove 100 g of filling compound for measuring)	Estimated drying <sup>1</sup> time at t <sub>i</sub> = 20 °C, max. 50 % relative humidity	
		without baking out	with baking out <sup>2</sup> at t <sub>f</sub> = 40 °C
Stone & ceramic coverings in a thin bed	1.3 %	6 days	24 h
Wood covering, parquet	0.3 %	8 days	36 h
Linoleum, PVC, vapour tight floor covering (the levelling mass has already been applied in accordance with Chapter 5.4)	0.3 %	not possible	≥ 48 h

<sup>1</sup> Only serves as a reference value and cannot be used to assess the readiness for covering!

<sup>2</sup> At t<sub>i</sub> = 20 °C, you must wait at least 4 hours after finishing applying the filling compound before beginning the baking out process.



### 5.3 Filling in a glass fibre cloth

- › If floor coverings are glued, a mesh must be inserted in the joining areas between the VarioComp boards and the blank boards in the form of glass fibre cloth (4×4 mm) and with an overlap of 200 mm (adhesion with e.g. tile adhesive).
- › For critical floor structures, we recommend that a 4×4 mm glass fibre cloth is inserted over the entire area.

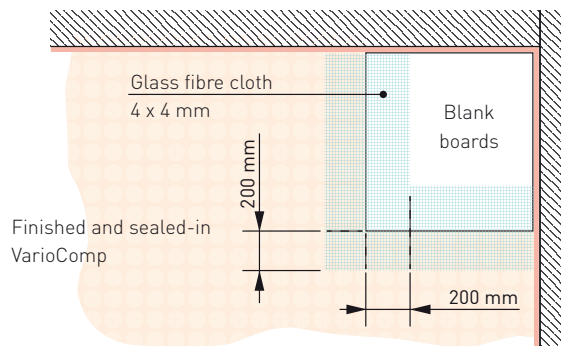

### 5.4 Application of an additional floor levelling compound

In the following cases, the finished VarioComp surface is additionally levelled off using a **calcium sulphate floor levelling compound**:

- › With soft floor coverings and artificial resin floors (see Chapter 5.7)
- › Depressions which exceed the standard tolerances (see Chapter 5.1) or which are too large for the floor covering according to the floor installer
- › If levelling out is needed

You should only start work once the VarioComp filling compound (0.3 % CM) has completely dried out (see also chap. 5.2).

Product examples (please observe the relevant manufacturer's instructions!):

Brand	Primer	Calcium sulphate floor-levelling compound
MAPEI	ECO PrimT Plus	Planitex Fast / Planitex Pro
SCHÖNOX	Schönox VD, VD Fix	Schönox APF
maxit	maxit floor 4716	maxit floor 4095
fermacell	Deep primer	Self-levelling compound
Thomsit	R766, R777	AS1, AS2
STAUF	D54	GS
BAUMIT	Grund	Nivello Quattro
ARDEX	Ardex P51	Ardex K22 F
WAKOL	D 3040	A 830
CASEA	casuprim HB	casufloor FS
BALL	Stoppap 1100 Gypsum	Stoppap P121
UFZUN	PE 360 PLUS	NC 105 / NC 110 / NC 112 Turbo / NC 115
Sopro	GD 749	Hybrid FSH 561
tilemaster adhesives	Prime Plus	Anhylevel

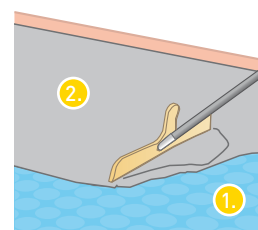

1. Primer
2. Calcium sulphate floor-levelling compound

## 5.5 Rooms exposed to high humidity

For surfaces which are exposed to high levels of humidity, sealing systems must be applied (e.g. bathrooms with shower trays - W3).

The wall construction must be sealed using sealing system and additional sealing tape.

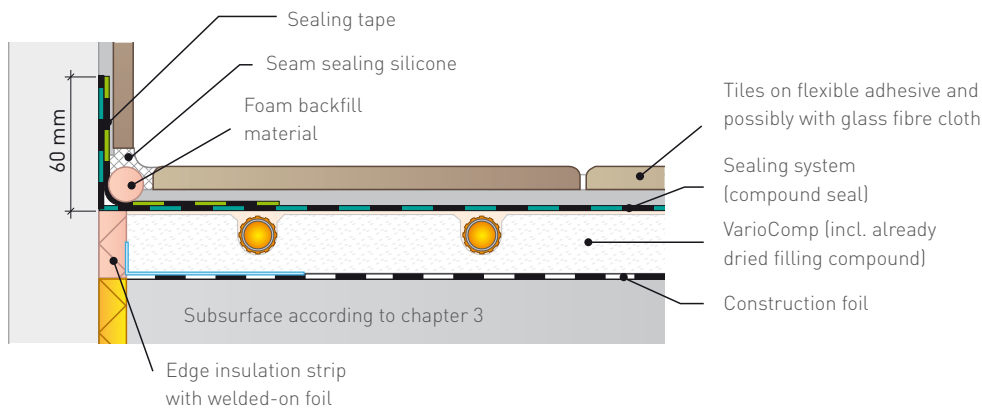

**<< Example:**  
Tiled floor covering exposed of moisture (W2/W3) (More details for tiled covering on VarioComp see chapter 5.6)

Use of primer and sealing system (compound sealing):

Stress group according to ÖN B 3407		Adhesive mortar with tile coverings	Primer	Sealing system
W1	Residential sector: living rooms, corridors, toilets, offices etc.	Calcium sulphate flexible adhesive mortar	Not required	Not required
		Cement flexible adhesive mortar	Required	Not required
W2	Residential sector: kitchen and rooms with similar usage Commercial sector: toilet systems	Only cement flexible adhesive mortar	In addition to the sealing system, when recommended by the manufacturer	Recommended
W3	Wall and floor surfaces without drainage (e.g. bathroom with shower tub higher than 20 mm above floor covering), toilet systems without floor drainage, porch	Only cement flexible adhesive mortar	In addition to the sealing system, when recommended by the manufacturer	Required
W4-W6	Wall and floor surfaces with drainage (e.g. shower with flush drain at the same level as the floor), swimming bath area, shower systems, industrial kitchen, balconies, terraces ...	No VarioComp floor heating possible.		

Product examples<sup>1</sup> of primer and sealing system (compound sealing):

Manufacturer	Primer	Sealing system
Ardex	Ardex P51	Ardex 8 + 9
Cimsec	Gipsgrundierung / Haftbrücke	Dichtflex CL51 / 2K Sealing CL49
PCI (BASF)	Gisogrund	Lastogum
Schönnox	Schönnox KH	Schönnox HA / 1K DS Premium
Mapei	Primer G	Mapegum WPS
Weber	weber.prim 801	weber.tec 822
Ceresit	CT 17 Primer	Shower/Bath Sealing
Sopro	GD 749	Flexible sealing compound FDF 525/527

<sup>1</sup> Please observe the relevant manufacturer's instructions

## 5.6 Tile, stone and ceramic coverings

See also the appropriate standards for laying tiles, boards and mosaics.

- › The surface must be dust-free.
- › Sealing systems must be used on surfaces exposed of moisture (see chapter 5.5).  
The wall boundaries must be sealed using appropriate sealing tape.
- › A flexible adhesive (S1 classified according to EN 12004) is used to bond the tiles. A primer must be applied if required by the adhesive manufacturer. This is particularly the case for flexible cement adhesives.
- › Flexible grouting mortar must be used for grouting.
- › After laying the tiles, boundaries with the walls are additionally sealed with silicone.



## 5.7 Soft floor coverings and synthetic resin floors

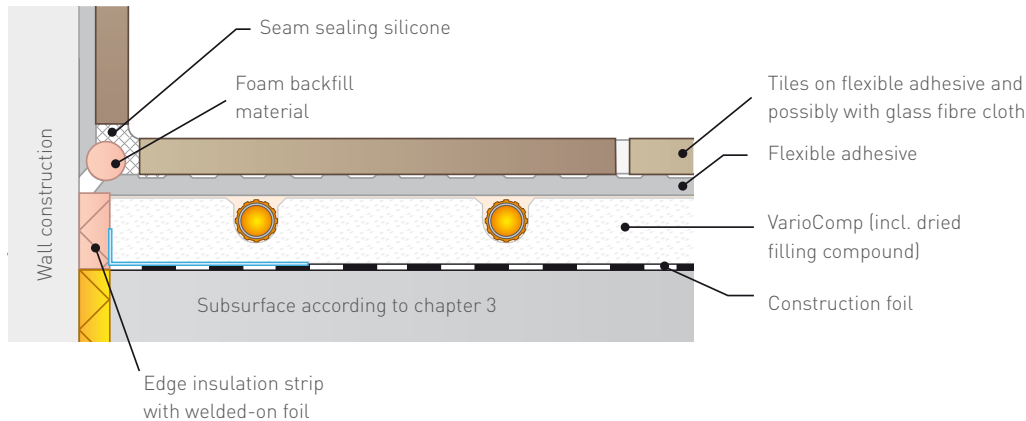

For soft floor coverings (e.g. carpet, linoleum) and synthetic resin floors, a calcium sulphate-based floor-levelling compound which has to be **provided by the costumer** and must be at least 4 mm thick is applied to completed VarioComp (see chapter 5.4).

**Caution:** Only use synthetic resin floors with low stresses during the hardening process! (Tensile bond strength max. 1 N/mm<sup>2</sup>).

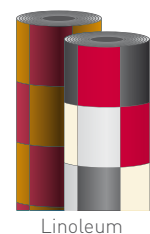
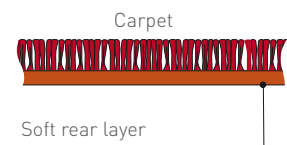
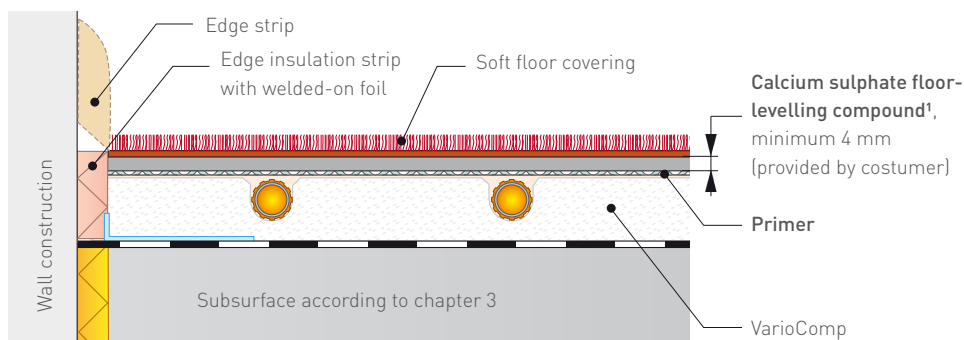

<sup>1</sup> Please observe the relevant manufacturer's instructions for the required primer or sealant of the VarioComp surface and of the planned floor-levelling compound. Product examples see chapter 5.4.

You should only start work once the VarioComp filling compound (0.3 % CM) has completely dried out.

## 5.8 Hard floor coverings (parquet, laminate, PVC boards)

- › Lay only floor coverings that are approved by the manufacturer for use with floor heating systems.  
Floors should have a maximum thermal insulation resistance of 0.15 m<sup>2</sup>K/W.  
Recommendation from Variotherm ≤ 0.1 m<sup>2</sup>K/W (incl. underlay strip/adhesive)
- › The differences in thermal output between the glued and floating design are negligible. Both versions have approximately the same surface temperatures. Note the information provided by the manufacturer!

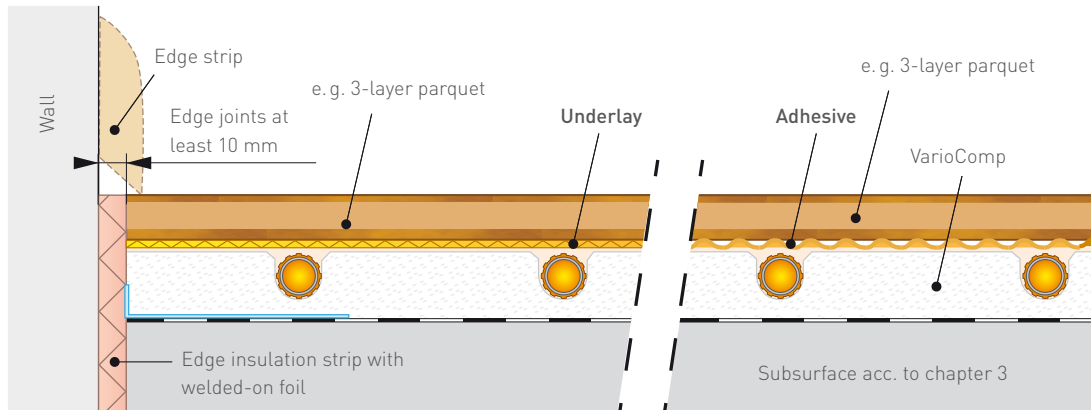
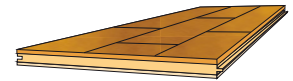

<b>FLOATING VERSION</b> <b>(recommended by Variotherm)</b>	<b>GLUED VERSION:</b>
<ul style="list-style-type: none"> <li>› Lay laminate, PVC boards or 3-layer parquet floating on an underlay strip suitable for floor heating (max. thickness 2 mm). Exception: With floor coverings with an underlay strip already laminated on the underside, no additional underlay strip is required.</li> <li>› The edge seam to adjacent components should be at least 10 mm.</li> </ul>	<ul style="list-style-type: none"> <li>› 2- or 3-layer parquet suitable for floor heating, without gluing the tongue and grooves. <b>Gluing of solid/solid wood floors is <u>not permitted!</u></b></li> <li>› Maximum flow temperature 40 °C (Maximum temperature limiter required!)</li> <li>› Gluing without base coat, with e.g.:               <ul style="list-style-type: none"> <li>- Mapei Ultrabond ECO S948 1K</li> <li>- Thomsit P 695</li> <li>- Ardex Premium AF 480 MS</li> <li>- Weitzer Parkett Profi-SMP glue no. 400-EC1</li> <li>- Sika SikaBond-52 Parquet, SikaBond-54 Parquet or equivalent adhesive (primer according per manufacturer's specifications).</li> </ul> </li> </ul>
<p><b>Advantages:</b> Cover easy to replace – no risk that the VarioComp will be damaged during dismantling. Costs of laying usually lower.</p>	<p><b>Advantages:</b> Almost no joint formation.</p>
<p><b>Disadvantages:</b> Possible joint formation due to material expansion. Sanding the parquet may be problematic (springing of the cover).</p>	<p><b>Disadvantages:</b> Parquet difficult to replace - VarioComp could be damaged during dismantling. Cost of laying usually higher.</p>



# 6 HEATING PRACTICE

## 6.1 Calculating the heating load

Along with the respective national annex, the EN 12831 standard will be used to calculate the heating load for the heated rooms.

Every room is considered individually. For the outside temperature, the locally acquired and standardised outdoor temperature  $T_{ne}$  is used.

Übersicht der Bauteile						
Code	Bezeichnung	U-Wert W/m²K	Rges m²K/W	Rsi m²K/W	Rse m²K/W	R-Baut m²K/W
AF01	Außenfenster	1,100	0,909	0,130	0,040	0,739
AT01	Außentür	1,700	0,588	0,130	0,040	0,418
AW01	Außenwand	0,220	4,545	0,130	0,040	4,375

Raum		$\Theta_{ext}$	$A_o$	$\Phi_{t,e}$	$\Phi_{t,i}$	$\Phi_{t,w}$	$\Phi_{t,ext}$	$\Phi_{t,ext}$	$\Phi_{t,ext}$	$\Phi_{t,ext}$
Nr.	Bezeichnung	°C	m²	W	W	W	W	W	W	W
Haus_EG		180,88	5427	3396				9160	0	9160
00.001.001	Eltern	20,0	29,10	833	833	501	46	15	1335	0
00.001.002	Kindler	20,0	20,49	762	762	343	54	19	1106	0
00.001.003	Vorraum	20,0	24,40	571	571	409	40	14	980	0

▲ Extract from a heating load calculation

## 6.2 Variotherm dimensioning software

Key values for individual heating circuits (flow/return temperature, the amount of water, pressure loss, number of circuits, allocation of the manifolds etc.) can be quickly and easily calculated or determined by entering the heating load into the Variotherm dimensioning software.

It can be found in our Professional Area at [www.variotherm.com/professional](http://www.variotherm.com/professional).

Building project: Simon Sample      ZIP: 2544      City: Leobersdorf      Date:      Processed by:

No. Room name	Floor space A <sub>o</sub> [m²]	Maximum length L <sub>o</sub> [m]	Heating load Q <sub>o</sub> [W]	Supplement heating load Q <sub>o</sub> Suppl. [W]	Room temp. t <sub>r</sub> [°C]	Heating system	Floor covering [m²] or pipe covering	Dimensioning temperature t <sub>fl</sub> [°C]	Mathematical			Practical			Supply pipe	Supply line length [m]	Pressure loss [mWC]	Flow quantity [l/h]	Distribution manifold number	Calculation of pressure loss and flow rate with 2 systems of one heating circuit (see manual).
									Dim.	Unit	Type	No. of circuits	Dim.	Unit						
G living room	53,00		2860		22	Modular floor heating	0,075	40/30	51,10 m²	FBHK10	8	6,62 m²	RA10	106	26		0,48	32	*1	
kitchen	17,20		1021		20	Modular floor heating	0,010	40/30	14,60 m²	FBHK15	2	6,25 m²	RA10	17	27		0,83	45	*1	
porch	5,00		458		18	Modular floor heating	0,010	40/30	5,00 m²	FBHK10	1	5,00 m²	RA10	7	27		0,55	41	*1	
bathroom	4,20		231		24	Modular floor heating	0,010	40/30	3,90 m²	FBHK10	1	4,20 m²	RA10	21	27		0,16	22	*1	
WC	2,00		134		20	Modular floor heating	0,010	40/30	2,00 m²	FBHK15	1	2,00 m²	RA10	32	27		0,05	15	(*1)	
B room 1	15,00		954		20	Modular floor heating	0,075	40/30	14,50 m²	FBHK10	3	5,00 m²	RA10	36	26		0,30	29	*2	
room 2	14,00		878		20	Modular floor heating	0,075	40/30	13,40 m²	FBHK10	2	7,00 m²	RA10	46	26		0,74	40	*2	
room 3	17,00		969		20	Modular floor heating	0,075	40/30	14,70 m²	FBHK10	3	5,66 m²	RA10	152	26		0,44	33	*2	
room 4	16,00		953		20	Modular floor heating	0,075	40/30	14,50 m²	FBHK10	3	5,33 m²	RA10	102	26		0,36	31	*2	
aisle	19,50		1624		20	Modular floor heating	0,010	40/30	19,50 m²	FBHK10	3	6,50 m²	RA10	-6	27		0,86	47	*2	
WC	3,50		273		20	Modular floor heating	0,010	40/30	3,30 m²	FBHK10	1	3,50 m²	RA10	18	27		0,17	26	*2	

Summary of the heating systems				
Amount	Unit	Heating system	Type	Pipe / Heating element
	m²	System wall heating	SWHK2	
	m²	System wall heating	SWHK3	
	m²	Modular wall heating	MWHK	
	m²	EasyFlex wall heating	EWHK77	
	m²	EasyFlex wall heating	EWHK115	
	m²	EasyFlex ceiling heating	EDKH77	
	m²	EasyFlex ceiling heating	EDKH115	
	m²	Modular ceiling heating	MDKH	
	m²	Screened floor heating	FBH10	
	m²	Screened floor heating	FBH15	
	m²	Screened floor heating	FBH20	
	m²	Screened floor heating	FBH25	
	m²	Screened floor heating	FBH30	
161,6	m²	Modular floor heating	FBHK10	1.616 m
	m²	Modular floor heating	FBHK15	
	m²	Industrial floor heating	FBHS20	
	m²	Industrial floor heating	FBHS25	
	m²	Industrial floor heating	FBHS30	
	m²	Industrial floor heating	FBHS35	
	m²	Industrial floor heating	FBHS40	
	m	Skirting heating	HL mini	
	m	Skirting heating	HL la	
	m	Skirting heating	HL lla	
	m	Trench heating	BKH1 mini	
	m	Trench heating	BKH1	
	m	Trench heating	BKH1 mini	
	m	Trench heating	BKH2	
	m	Trench heating	BKH2	
	m	Supply pipe	16x2	
	m	Supply pipe	11,6x1,5	

Summary of pipe length by line					
Room name	Ø 20 [m]	Ø 16 [m]	Ø 11,6 [m]	HL18 [m]	HLm18 [m]
living room	529,6				
kitchen	120,0				
porch	43,5				
bathroom	42,0				
WC	20,0				
room 1	150,0				
room 2	140,0				
room 3	169,8				
room 4	169,9				
aisle	195,0				
WC	36,0				
<b>Total</b>	<b>1609,8</b>				

	t <sub>fl</sub>	Number of heating circuits	Flow quantity manifold	Pressure loss manifold	Manifold notation according to drawing
	°C		l/h	mWC	
Distribution manifold #1	40/30	12	424	0,9	
Distribution manifold #2	40/30	15	526	1,0	
Distribution manifold #3					
Distribution manifold #4					
Distribution manifold #5					
Distribution manifold #6					
Distribution manifold #7					
Distribution manifold #8					
When all distribution manifolds are fed via one pump, the following applies:					
Total flow quantity:			950 kg/h		
Maximum pressure loss from distribution manifold incl. 0.1 mWC for max. opened valve				0,96 mWC	
<b>Summary of the floor heating surface area:</b>					
Screened floor heating				0,0 m²	
Modular floor heating				161,6 m²	
Industrial floor heating				0,0 m²	
<b>Summary of loads:</b>					
Total heating load				10.365,0 W	
Total installed load				10.889,0 W	
<b>Total filling water:</b>					
Total filling water:				93,7 liter	
<b>Notes:</b>					

▲ Variotherm dimensioning software example for heating

### 6.3 Heat outputs

HEAT OUTPUT for a floor covering with a thermal resistance<sup>1</sup> of  $d/\lambda = 0.01 / 0.05 / 0.075 / 0.10 \text{ m}^2\text{K/W}$

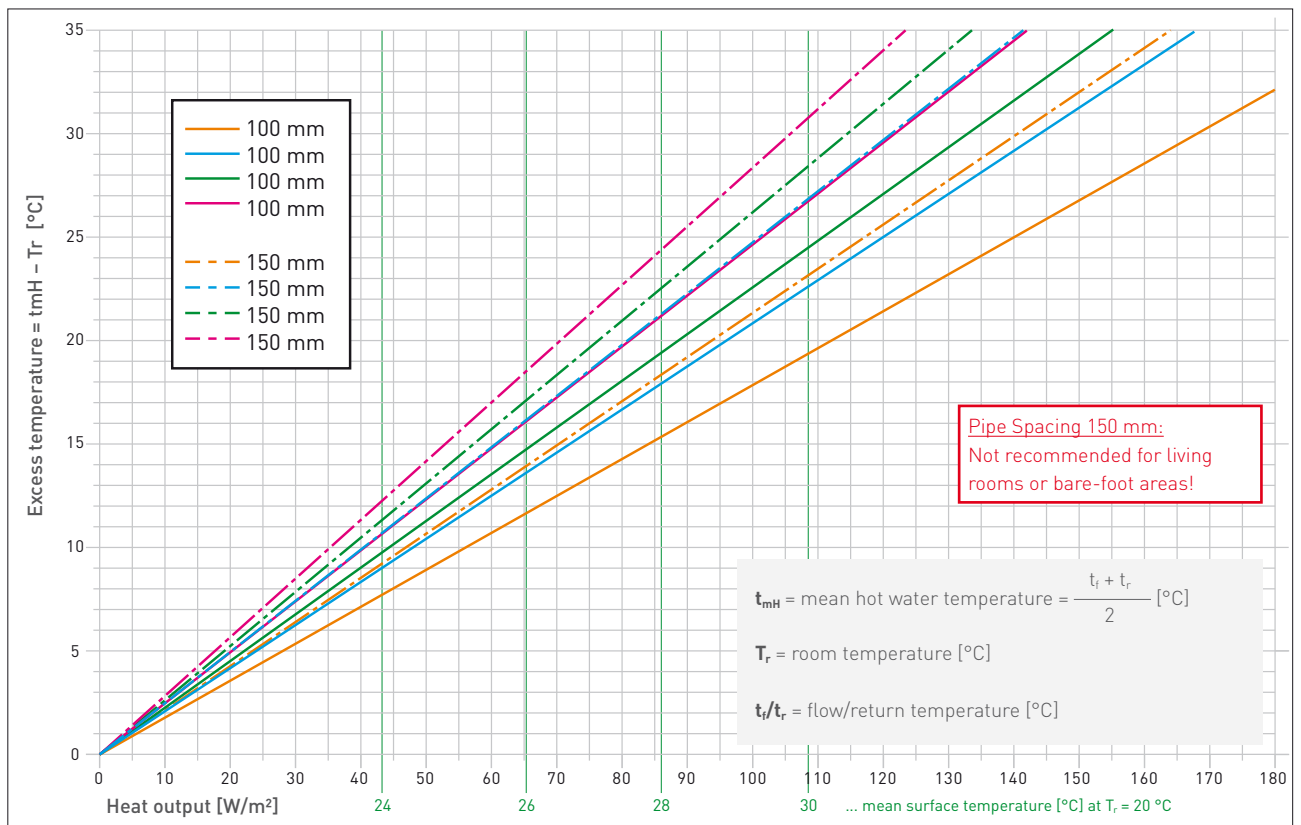

HEAT OUTPUT for a floor covering with a thermal resistance<sup>1</sup> of  $d/\lambda = 0.12 / 0.14 / 0.16 / 0.18 \text{ m}^2\text{K/W}$

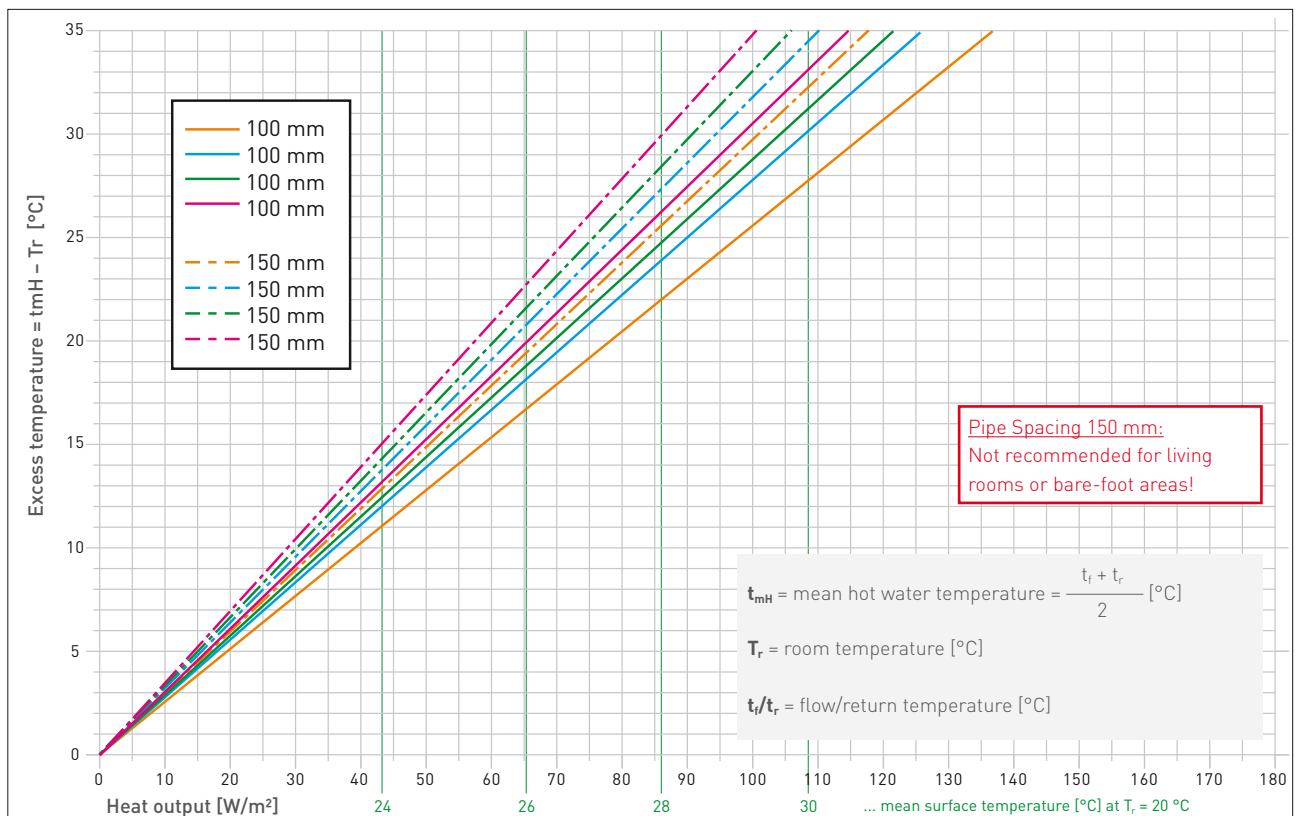

<sup>1</sup> Guidelines for the thermal resistance of various floor coverings see chapter 5.1

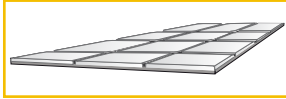

Tiles, ceramic and natural stone coverings

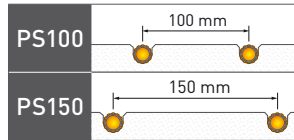

PS150: Not recommended for living rooms or bare-foot areas!

Thermal resistance  $d/\lambda$ : 0.01 m<sup>2</sup>K/W

$t_f/t_r$ [°C]	$t_{mH}$ [°C]	Heat output [W/m <sup>2</sup> ] at room temperature $T_r$										$T_o$ [°C] (at $T_r = 20$ °C)	
		$T_r = 15$ °C		$T_r = 18$ °C		$T_r = 20$ °C		$T_r = 22$ °C		$T_r = 24$ °C		PS100	PS150
		PS100	PS150	PS100	PS150	PS100	PS150	PS100	PS150	PS100	PS150		
30/20	25.0	55	46	39	32	27	23	16	14	-	-	23	22
30/25	27.5	69	58	53	44	41	35	30	25	19	16	24	23
35/25	30.0	83	70	67	56	55	46	44	37	33	28	25	24
35/28	31.5	92	77	75	63	64	53	53	44	41	35	26	25
35/30	32.5	97	82	81	67	69	58	58	49	47	39	26	25
37.5/32.5	35.0	111	93	94	79	83	70	72	60	61	51	28	26
40/30	35.0	111	93	94	79	83	70	72	60	61	51	28	26
40/35	37.5	125	105	108	91	97	82	86	72	75	63	29	28
45/35	40.0	139	117	122	103	111	93	100	84	89	75	30	29
45/40	42.5	153	128	136	114	125	105	114	96	103	86	32	30
50/40	45.0	167	140	150	126	139	117	128	107	117	98	33	31
50/45 <sup>1</sup>	47.5	181	152	164	138	153	128	142	119	131	110	34	32

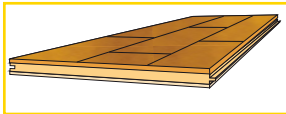

Thin parquet floors, laminates and carpets

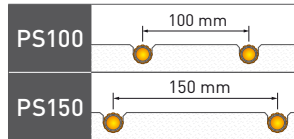

PS150: Not recommended for living rooms or bare-foot areas!

Thermal resistance  $d/\lambda$ : 0.075 m<sup>2</sup>K/W

$t_f/t_r$ [°C]	$t_{mH}$ [°C]	Heat output [W/m <sup>2</sup> ] at room temperature $T_r$										$T_o$ [°C] (at $T_r = 20$ °C)	
		$T_r = 15$ °C		$T_r = 18$ °C		$T_r = 20$ °C		$T_r = 22$ °C		$T_r = 24$ °C		PS100	PS150
		PS100	PS150	PS100	PS150	PS100	PS150	PS100	PS150	PS100	PS150		
30/20	25.0	44	37	30	26	22	18	13	11	-	-	22	22
30/25	27.5	55	47	42	36	33	28	24	20	15	13	23	23
35/25	30.0	66	56	53	45	44	37	35	30	26	22	24	23
35/28	31.5	72	62	59	51	50	43	42	36	33	28	25	24
35/30	32.5	77	66	64	55	55	47	46	39	37	32	25	24
37.5/32.5	35.0	88	75	75	64	66	56	57	49	48	41	26	25
40/30	35.0	88	75	75	64	66	56	57	49	48	41	26	25
40/35	37.5	99	85	86	74	77	66	68	58	59	51	27	26
45/35	40.0	110	94	97	83	88	75	79	68	70	60	28	27
45/40	42.5	121	104	108	93	99	85	90	77	81	70	29	28
50/40	45.0	132	113	119	102	110	94	101	87	92	79	30	29
50/45 <sup>1</sup>	47.5	143	123	130	112	121	104	112	96	103	89	31	30

$$t_{mH} = \text{mean hot water temperature} = \frac{t_f + t_r}{2} \text{ [°C]}$$

$$T_o = \text{mean surface temperature [°C]}$$

$$T_r = \text{room temperature [°C]}$$

$$t_f/t_r = \text{flow temperature / return temperature [°C]}$$

<sup>1</sup> The flow temperature must never exceed 50 °C

## 6.4 Pressure loss

Example: The total pressure loss of a 7.2 m<sup>2</sup> VarioComp heating surface (one heating circuit) is to be calculated. The desired flow/return temperature is 37.5/32.5 °C, resulting in a heat output of 66 W/m<sup>2</sup> at a room temperature of 20 °C (thin parquet, d/λ = 0.075 m<sup>2</sup>K/W).

Calculation of the flow rate ω from the pressure loss diagram:

$$Q = 475.2 \text{ W (} 66 \text{ W/m}^2 \times 7.2 \text{ m}^2\text{)}$$

$$\Delta T = 5 \text{ K (} t_f - t_r = 37.5 \text{ K} - 32.5 \text{ K)}$$

$$c = 1.163 \text{ Wh/kgK (specific heat capacity of water)}$$

$$m = Q \div c \div \Delta T$$

$$= 475.2 \text{ W} \div 1.163 \text{ Wh/kgK} \div 5 \text{ K} = 81.7 \text{ kg/h (l/h)}$$

$$Q = m \times c \times \text{delta } T$$

The flow rate ω is therefore 0.4 m/s and the pressure loss is 335 Pa/m

Pipe length for 7.2 m<sup>2</sup> heating surface = 72 m (1 m<sup>2</sup> = 10 m pipe at 100 mm pipe spacing)

- **Δp for 7.2 m<sup>2</sup> VarioComp:** 335 Pa/m × 72 m = **24 120 Pa** (pipe laid „endless“)

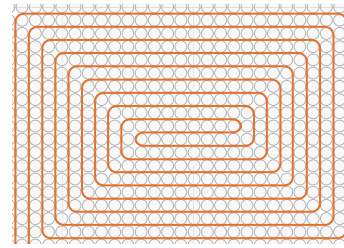

Maximum flow rate per heating circuit of the VarioManifold:
160 l/h

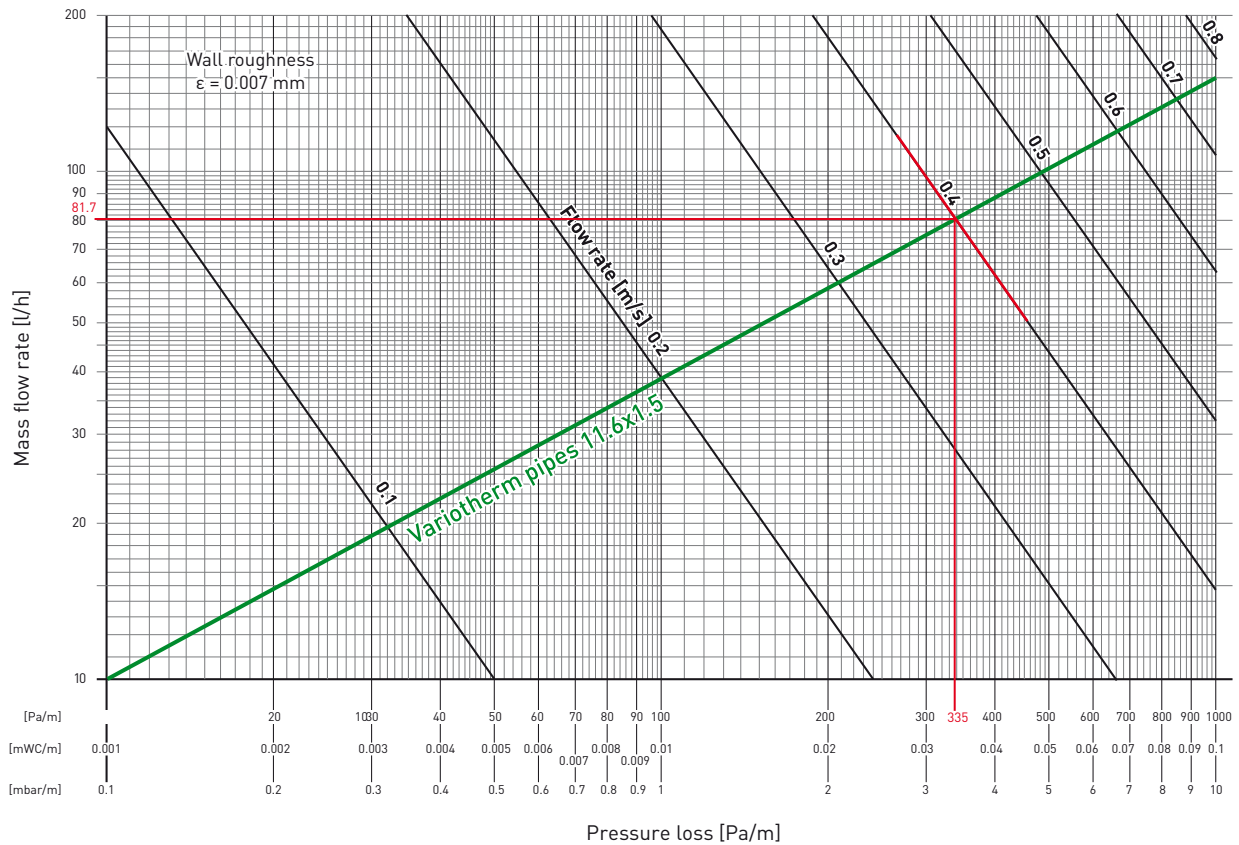

In case of setting a press-fit coupling for connecting residual lengths of pipe:

- **Δp for 1 pce. press-fit coupling 11.6 × 11.6:**  
 $\zeta \times \rho/2 \times \omega^2 = 7.2 \times 500 \text{ kg/m}^3 \times (0.4 \text{ m/s})^2 = +576 \text{ Pa}$

Press-fit coupling	Coefficient of resistance ζ [Zeta]
11.6 × 11.6	7.2



# 7 PROTOCOLS

## 7.1 Leak-tightness test in accordance with EN 1264-4

The VarioComp floor heating system circuits are to be tested for leak-tightness using a water pressure test before pouring in the VarioComp filling compound. The test pressure should be min. 4 bar and max 6 bar. Due to the initial pipe expansion it may be necessary to re-pump the test pressure. If there is a risk of freezing, appropriate measures should be taken, e.g. use of antifreeze and controlling the building's temperature.

The Leak-tightness test can also be carried out with compressed air as an alternative.

The test pressure in this case is max. 3 bar.

Construction project: \_\_\_\_\_

Building owner/Occupant: \_\_\_\_\_

Client: \_\_\_\_\_

Heating installation technician: \_\_\_\_\_

Architect: \_\_\_\_\_

Other: \_\_\_\_\_

- › Installation completion of the VarioComp boards including connections and piping on: \_\_\_\_\_
- › Leak-tightness is carried out with  water  compressed air
- › Pressure test started on: \_\_\_\_\_ with test pressure of \_\_\_\_ bar
- › Pressure test completed on: \_\_\_\_\_ with test pressure of \_\_\_\_ bar
- › VarioComp filling compound added. Begun on: \_\_\_\_\_ Completed on: \_\_\_\_\_
- › The system water was treated (e.g. as per ÖNORM H 5195-1)  Yes  No
- › Antifreeze was added to the system water  Yes  No
- › The VarioComp has been baked out as described in chapter 5.2 with  $t_f/t_r = \text{___} / \text{___} \text{ } ^\circ\text{C}$ :  
 No Yes:  24 h  36 h  48 h  \_\_\_ h
- › Floor covering:  Tiles  Parquet  Carpet, linoleum  Other \_\_\_\_\_
- › Completing the laying work on: \_\_\_\_\_
- › Start of heating (max. flow temperature of the VarioComp floor heating  $t_f = 50 \text{ } ^\circ\text{C}$ ) on: \_\_\_\_\_

Approval:

\_\_\_\_\_  
Building owner/Occupant/Client

\_\_\_\_\_  
Construction management/Architect

\_\_\_\_\_  
Heating installation technician

## 7.2 Functional heating (in compliance with EN 1264-4 or BVF<sup>1</sup>)

The functional heating serves as verification and proof of the creation of a defect-free installation for the heating installer and/or drywall builder.

The functional heating is only carried out after the VarioComp filling compound has been applied. The VarioComp filling compound must have dried out completely.

The maximum calculated flow temperature must be maintained for at least 1 day.

Construction project: \_\_\_\_\_

Building owner/occupant: \_\_\_\_\_

Client: \_\_\_\_\_

Heating installer: \_\_\_\_\_

Architect: \_\_\_\_\_

Others: \_\_\_\_\_

### Preheating of the VarioComp floor heating

- › Completion work finished: \_\_\_\_\_
- › Preheating started with constant max. calculated flow temperature: \_\_\_\_\_ |  $t_f =$  \_\_\_\_\_ °C
- › End of functional heating : \_\_\_\_\_  
If there is a risk of freezing, appropriate measures should be taken, (e. g. frost protection mode).
- › The rooms were ventilated without draughts and all windows and external doors closed after switching off the surface heating system:  Yes  No
- › Operating state and outdoor temperature on handover:

When switched off after the preheating phase, the VarioComp floor heating must be protected against draughts and from cooling down too quickly until it has cooled down completely.

Approval:

\_\_\_\_\_  
Building owner/Occupant/Client

\_\_\_\_\_  
Construction management/Architect

\_\_\_\_\_  
Heating installer

## 7.3 Commissioning

Please note that the flow temperature (heating water) of the VarioComp floor heating may not exceed  $t_f = 50$  °C. The main stop valves at the distributor station, and the heating circuit shut-offs are to be opened. The entire system is to be deaerated thoroughly. The circulation pump may be switched on after deaeration. After commissioning, the VarioComp floor heating system can be considered maintenance-free.

(Subject to technical modifications without notice.)

<sup>1</sup> BVF = Bundesverband Flächenheizungen und Flächenkühlungen e.V.



## ENJOY THE COMFORT & SAVE ENERGY

That's why our customers love us:

Heating and cooling optimised for COMFORT in all rooms!

Fast and friendly service, ANSWERS backed up with expertise!

Always in tune with the latest technology, INNOVATION guaranteed!

Everything CLEAR and SIMPLE, in writing of course!

PROFESSIONALISM at all times, from the first contact to the reference list!

## VARIO THERM SINCE 1979

Variotherm is an Austrian model plant with hundreds of partners in Austria, Europe and around the world.



VBOOK8\_EN | 8/2024

Your Variotherm Partner

VARIO THERM HEIZSYSTEME GMBH

GÜNSELSDORFER STRASSE 3A

2544 LEOBERSDORF

AUSTRIA

Phone: +43 [0] 22 56 - 648 70-0

office@variotherm.com www.variotherm.com

All rights pertaining to distribution and translation, in whole or in part, including film, radio, television, video recording, Internet, photocopying and reprinting, are reserved. Subject to mistakes and printing errors. Misprints and errors excepted.